



Precision
Agriculture



Mining Products

2024 v.1.0

/ Product Catalog



Contents

→ Introduction	6	→ Air Valves	
→ Leach Lines		DG10 / D40	84
Leach Line™ X.....	11	D40L	87
Leach Line™ A.....	16	AV10	91
Leach Line™ U.....	22	D20	93
Leach Line™ D.....	27	D25	96
→ Sprinklers		D26	100
GyroNet™ Turbo.....	34	→ Water Meters	
MegaNet™	37	Octave™	109
MegaStand™	40	Ultraf™	111
MegaStand™ floating base	41	→ Filters	
→ Pipes		Manual Disc Filters	114
FlexNet™ HP	43	Plastic Screen Filters	117
→ Connectors		Metal Screen Filters	119
Dripline Connectors	46	Hydrocyclone.....	132
FlexNet™ HP connectors kits	48	Netafim™ Products Warranty.....	136
→ Pressure Regulator			
In-Line PRV	52		
→ Valves			
75 Series.....	55		
90 Series.....	59		
Flushing valve with timer.....	62		
100 Series.....	64		
ALD Diaphragm Resistance.....	67		
True Union Ball Valve	68		
Angle Seat "Y" Valves.....	75		
PVC Butterfly Valves	78		
Metal Butterfly Valves.....	80		

Products appearing in this catalog may be covered by one or more of the following US Patent Nos. 7644735, 7410108 and other U.S. patents pending or corresponding issued or pending foreign patents. All rights are reserved. You are specifically prohibited and not allowed to reproduce, copy, duplicate, manufacture, supply, sell, hire, distribute or adapt all or any part of this publication including any packaging. Netafim™, are trademarks of Netafim™ Ltd., registered in the U.S. and other countries. We endeavor to provide accurate, quality and detailed information. However we cannot accept liability for your reliance on the provided information and you are advised to independently seek professional advice from Netafim™ and/or its authorized representatives. There is no undertaking by us that the provided information or any part thereof is accurate, complete or up to date. Mention of third-party products is for informational purposes only and constitutes neither an endorsement nor a recommendation. Netafim™ assumes no responsibility with regard to the performance or use of these products. In no event shall Netafim™ be liable for any indirect, incidental, special or consequential damages.



/ About Netafim™

Netafim™, Orbia's Precision Agriculture business, is the world's largest irrigation company and the global leader in precision agriculture solutions committed to fight scarcity of food, water and land, for a sustainable future.

Founded in 1965, Netafim™ pioneered the drip revolution, creating a paradigm shift toward precision irrigation. Today, specializing in end-to-end solutions from the water source to the root zone, Netafim™ delivers irrigation and greenhouse projects, as well as landscape and mining solutions supported by engineering, project management and financing services. Netafim™ is also leading the way in digital farming, integrating real-time monitoring, analysis and automated control into one state-of-the-art system.

With 33 subsidiaries, 19 manufacturing plants, 2 recycling plants and 5000 employees worldwide, Netafim™ delivers innovative, tailor-made irrigation and fertigation solutions to millions of farmers, allowing smallholders to large-scale agricultural producers, in over 110 countries, to **grow more with less™**.

See how Netafim's solutions are driving sustainable agriculture and a food secure future at www.netafim.com

/ About Orbia

Orbia is a company driven by a shared purpose: to advance life around the world. Orbia operates in the Polymer Solutions (Vestolit and Alphagary), Building and Infrastructure (Wavin), Precision Agriculture (Netafim™), Connectivity Solutions (Dura-Line) and Fluorinated Solutions (Koura) sectors.

The five Orbia business groups have a collective focus on expanding access to health and wellness, reinventing the future of cities and homes, ensuring food and water security, connecting communities to information and accelerating a circular economy with basic and advanced materials, specialty products and innovative solutions. Orbia has commercial activities in more than 110 countries and operations in over 50, with global headquarters in Boston, Mexico City, Amsterdam and Tel Aviv.

To learn more, visit: www.orbia.com



Introduction

Netafim™ offers a comprehensive products and services portfolio for Mining that includes the hydraulic design, driplines, sprinklers, connectors, pipes, valves, filters and system accessories.

The applications that are relevant for Netafim™ include:

1. Leaching
 - A. Heap Leaching
 - B. Bio-Heap Leaching
 - C. Dump Leaching
 - D. In-Situ Leaching
2. Evaporation
3. Dust control

/ Leaching

A. Heap Leaching

The mined ore in copper, gold, nickel and uranium is crushed and heaped on an impermeable liner (geomembrane and geotextile) The pad is then irrigated with a leach solution, using drippers or sprinklers, to dissolve (extract) the metals. This is a closed process that generally takes from one month for oxide ores and even several years in the case of sulfide ores.

The leach solution containing the dissolved minerals is then collected in a PLS pond (Pregnant Leaching Solution), treated in a process plant to recover the mineral and recycled to a refine pond and from there to the heap after reagent levels are adjusted.

B. Bio Heap Leaching

Used for the extraction of Copper from sulfide ores, similar to the regular heap leaching process but with the help of bacteria, usually a long irrigation cycle is required.

C. Dump Leaching

Heap leaching of low-grade minerals. In this case the mined ore is not crushed.

D. In Situ Leaching

Used mainly for the extraction of Uranium in the USA, Australia and Kazakhstan. The leaching solution is pumped into or irrigated directly on ore body and then collected from a lower borehole.

/ Evaporation

Using sprinklers such as the GyroNet™ Turbo to help the mine dispose of large amounts of water from its tailings.

/ Dust control

Providing controlled water systems for dust generated on the mine's road by heavy trucks and machinery.

Mining irrigation characteristics compared to irrigation in agriculture:

1. High flow rate and nonstop irrigation - flow rate can reach 10-12 l/hr/m², for a period of months and even years of nonstop irrigation
2. The solution used for irrigation contains chemicals such as sulfuric acid (for the extraction of copper, uranium and nickel) or cyanide (for the extraction of gold/silver)
3. Closed loop – the same drop goes through the dripper again and again, hence dirt is accumulated and with the chemicals that are involved in the process (activated carbon, organic leaching materials acids etc.), which can cause a high rate of clogging.
4. Non-even surface - the heap surface is not completely even and in some cases there is a need to irrigate also the slopes.

The design and components of the Netafim™ irrigation system include features tailored specifically to mining irrigation:

1. Special design aimed at reaching the highest level of uniformity to ensure high clogging resistance that assures high recovery rates.
2. All the products are made of chemical resistant raw materials.
3. The design includes filtration systems and constant flushing of the driplines, either automatic or manual.
4. A drop migration prevention clip can be pre-installed on the dripline, to ensure the highest uniformity on non-even surfaces. Pressure-compensated drippers can be used on slopes.

→ What do we do in heap leaching?

Hydrometallurgy – Sx/Ew Process For Metal Extraction

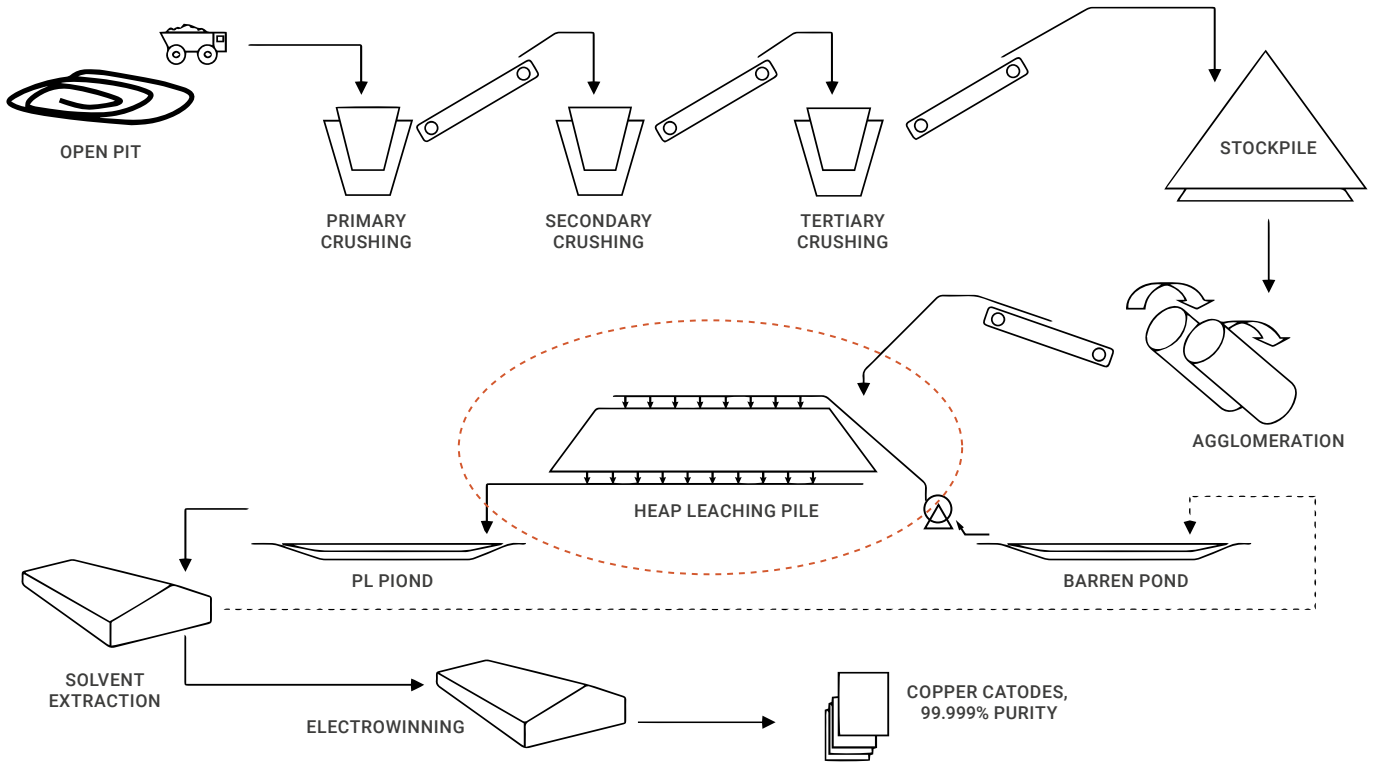

→ Uniform precolation all over the pad

Heap leaching pad

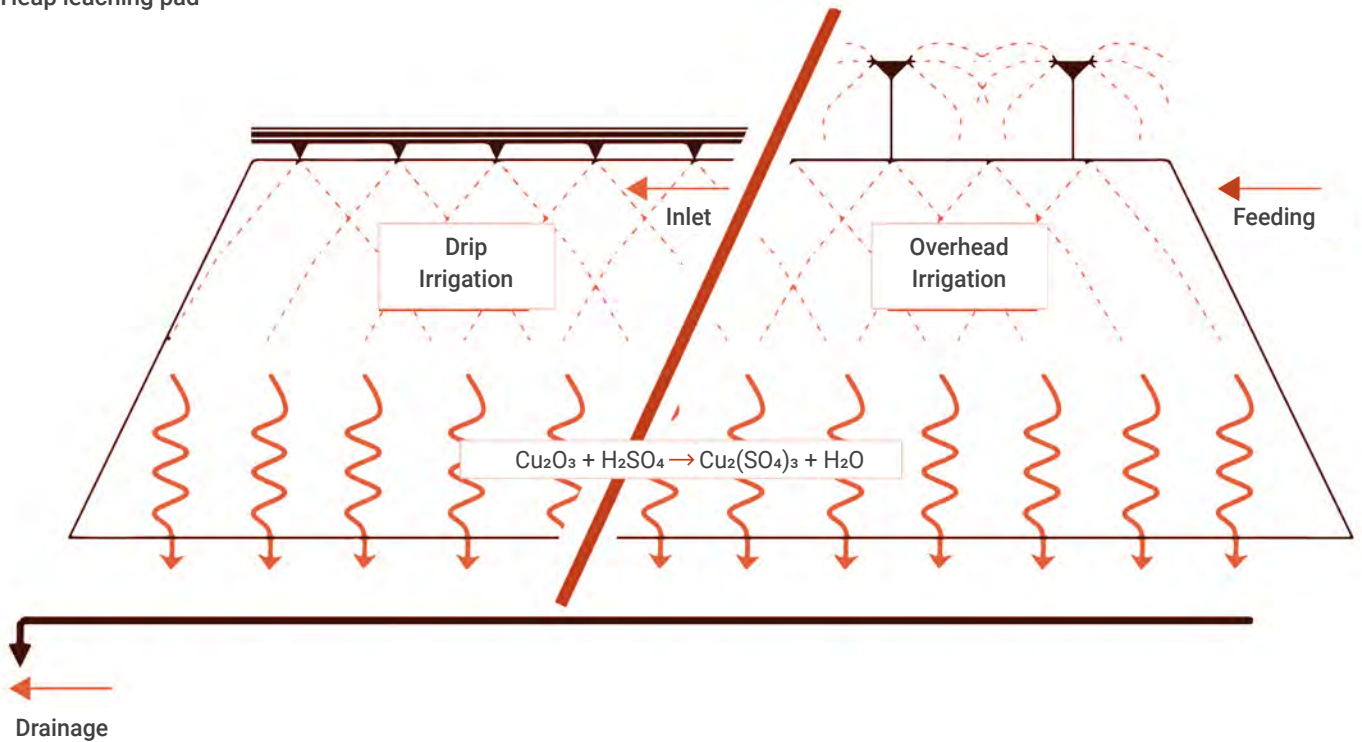

→ Mining pile on-site system

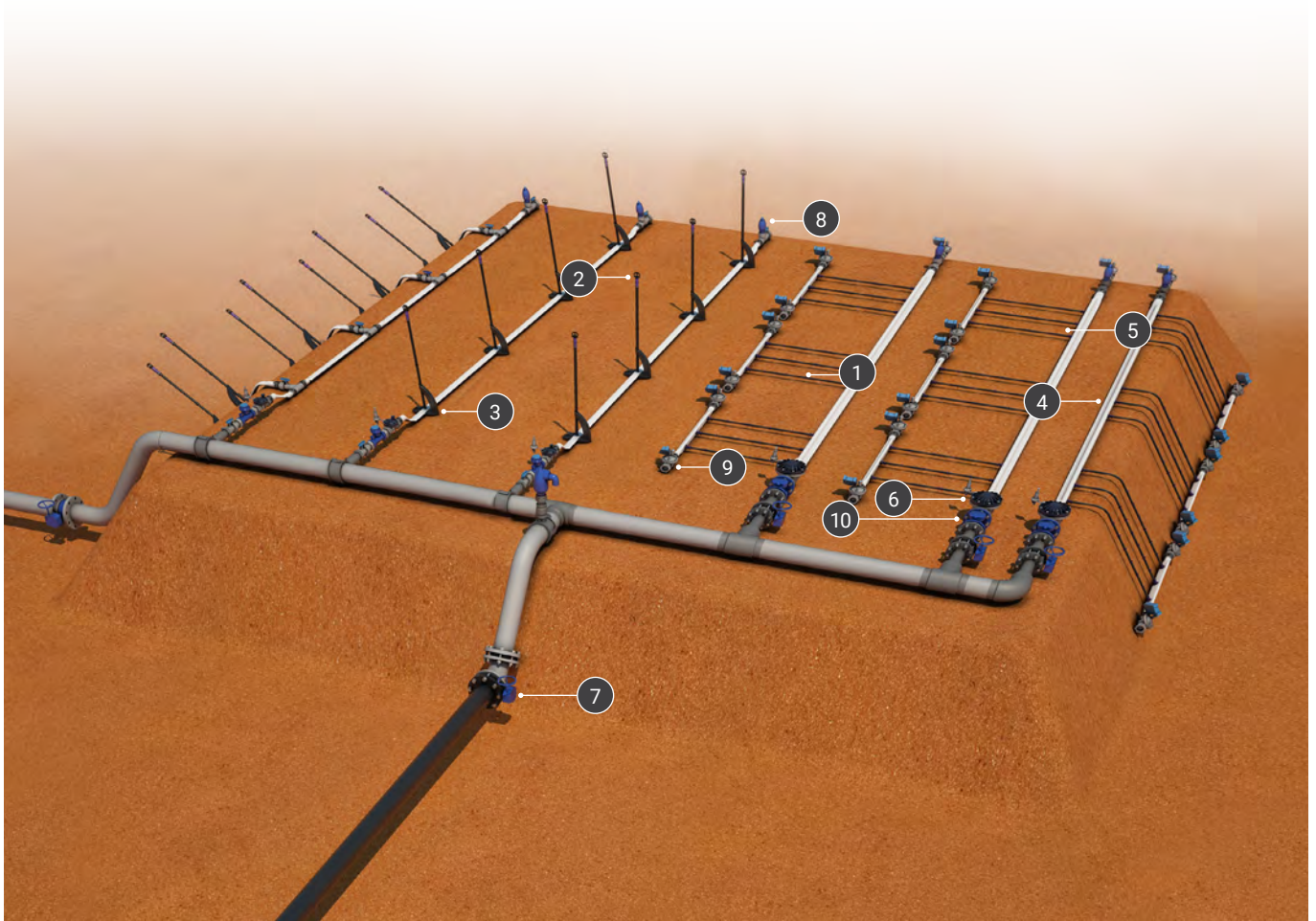

1. Leach Lines

A mining industry leading portfolio, of pressure-compensated and non-pressure-compensated drippers. For heap leaching of Copper, Gold and Silver mines.

2. Sprinklers

Wide variety of sprinklers suitable for all heap leaching requirements. For Copper, Gold and Silver mines.

3. MegaStand™

Unique, simple and reliable sprinkler stands for installation with Netafim™ flexible pipes.

4. FlexNet™ Flexible Pipes

Simple and reliable solution, as part of Netafim™ innovative mainline and sub-mainline piping portfolio.

5. Connectors

A full range of required pipe connecting solutions (barb, twist lock, compression). Including all the needed adapters and many additional accessories.

6. Hydraulic Control Valves

PVC, Polypropylene and Stainless Steel control valves. Suitable for any required control function.

7. Manual Valves

Wide range of butterfly valves, made from PVC or highly resistant metals, with Stainless Steel shaft & disc and EPDM sealings. Various PVC ball valves, with Viton O-rings, designed especially for the mining industry.

8. Air Valves

Polypropylene air valves, high chemical resistance, uniquely designed for any mining application.

9. Flushing Valves

For an easy, automated flushing of the fluids in the system. With simple and reliable DC controller.

10. Ultrasonic Water-Meters

Full range of high-end, accurate and reliable meters, all made from highly resistant materials. Available with various pulse outputs. Including small diameters of PVC, chemical resistant meters.

→ System head control

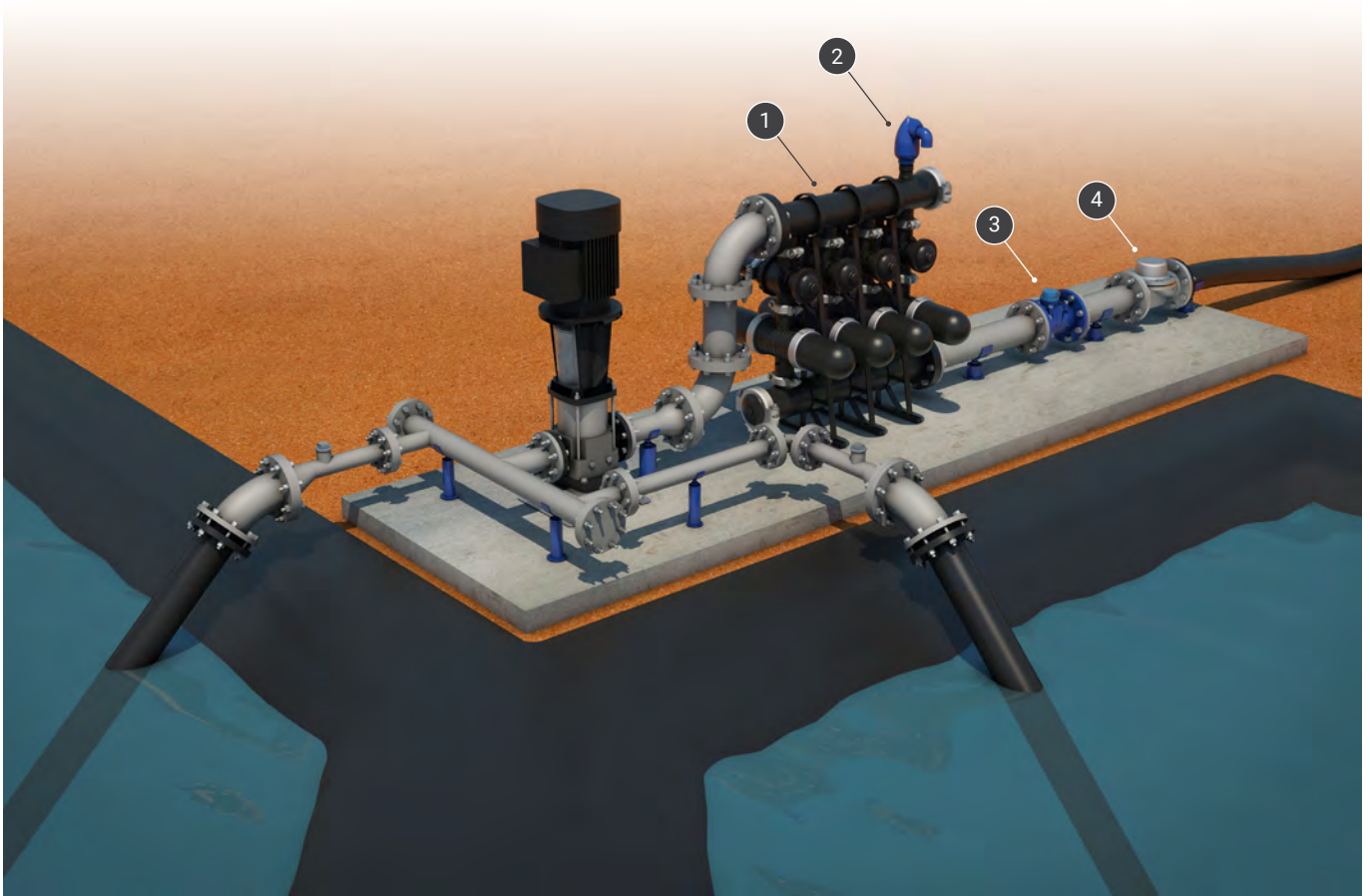

1. Filtration system

Complete filtration portfolio including unique disc or screen filters suitable for all heap leaching mines such as Copper, Gold and Silver.

2. Air valve

Polypropylene air valves, high chemical resistance, uniquely designed for any mining application.

3. Water-meter

Available with various pulse outputs. Including small diameters of PVC, chemical resistant meters.

4. Hydraulic control valve

PVC, Polypropylene and Stainless Steel control valves. Suitable for any required control function.

Leach Lines



Leach Line™ X

Heap leaching dripline.
Integral non-pressure-compensated.
Superior clogging resistance.

→ 16009 - 16010 - 16012 - 20010 - 20012



High clogging
resistance



Wide filtration
area



Wide water
passages

/ Benefits & Features

- **High clogging resistance** Even with challenging solution quality, with self-cleaning labyrinth that flushes debris throughout operation.
- **Wide filtration area** Ensures optimal performance even under harsh solution conditions, preventing the entrance of sediments into the drippers.
- **Wide water passages** TurboNet™ labyrinth ensures wide solution passages, large deep and wide cross-section that improves clogging resistance.
- **Anti-migration clip (smart clip)**  Prevents solution migration on uneven surfaces and slopes. Economical - saves labor. Pre-installed on the dripline during production (optional).

/ Specifications

- Maximum operating pressure according to driplines diameters and wall thickness. See tables below.
- Recommended filtration: 200 micron / 80 mesh. Filtration method selected based on the kind and concentration of dirt particles contained in the solution. Wherever sand exceeding 2 ppm exists in the solution, a Hydrocyclone should be installed before the main filter. Where sand/silt/clay solids exceed 100 ppm, pre treatment it should be applied following Netafim™ expert instructions.
- TurboNet™ labyrinth with large water passage.
- Weldable into thick wall driplines (0.90, 1.00, 1.20 mm).
- Injected dripper, very low CV.
- High UV resistance. Resistant to chemicals used in heap leaching mines.
- Compliance ISO 9261 international standards.

→ Drippers technical data

16009, 16010, 20010 - 0.9 and 1.0 mm wall thickness driplines

Flow rate* (l/h)	Max. working pressure (bar)**	Water passages dimensions width-depth-length (mm)	Filtration area (mm ²)	Constant K	Exponent X	Recommended filtration (micron)/(mesh)
1.00	3.0 / 3.5	0.60 x 0.80 x 75	70	0.348	0.46	200 / 80
1.50		0.73 x 0.90 x 75	70	0.520	0.46	200 / 80
2.00		0.76 x 1.09 x 75	70	0.693	0.46	200 / 80
4.00		1.06 x 1.40 x 75	76	1.387	0.46	200 / 80
8.00		1.68 x 1.40 x 37	76	2.774	0.46	200 / 80

* Flow rate at 1.0 bar pressure ** According to dripline wall thickness

16012, 20012 - 1.2 mm wall thickness driplines

Flow rate* (l/h)	Max. working pressure (bar)	Water passages dimensions width-depth-length (mm)	Filtration area (mm ²)	Constant K	Exponent X	Recommended filtration (micron)/(mesh)
1.05	4.0	0.60 x 0.80 x 75	70	0.364	0.46	200 / 80
1.50		0.73 x 0.90 x 75	70	0.520	0.46	200 / 80
2.10		0.76 x 1.09 x 75	70	0.728	0.46	200 / 80
4.20		1.06 x 1.40 x 75	76	1.456	0.46	200 / 80
8.40		1.68 x 1.40 x 37	76	2.913	0.46	200 / 80

* Flow rate at 1.0 bar pressure

→ Driplines technical data

Model	Inside diameter (mm)	Wall thickness (mm)	Outside diameter (mm)	Max. working pressure (bar)	Max. flushing pressure (bar)	Kd
16009	14.20	0.90	16.00	3.0	3.9	0.40
16010	14.20	1.00	16.20	3.5	4.6	0.40
16012	14.20	1.20	16.60	4.0	5.2	0.40
20010	17.50	1.00	19.50	3.5	4.6	0.10
20012	17.50	1.20	19.90	4.0	5.2	0.10

→ Driplines packaging data (on bundles coils)

Model	Wall thickness (mm)	Distance between drippers (m)	Coil length (m)	Average* coil weight (kg)	Coils in a 40 feet container (units)	Total in a 40 feet container (m)
16009	0.90	0.15 to 1.00	500	20.7	330	165000
16010	1.00	0.15 to 1.00	500	23.0	330	165000
16012	1.20	0.15 to 1.00	400	22.3	352	140800
20010	1.00	0.15 to 1.00	300	16.7	330	99000
20012	1.20	0.15 to 1.00	300	20.2	330	99000

* Calculated weight average. For further details see "Average Coil Weight Disclaimer".

→ Driplines packaging data (on bundles coils) with assembled anti-migration clips

Model	Wall thickness (mm)	Distance between drippers (m)	Coil length (m)	Average* coil weight (kg)	Coils in a 40 feet container (units)	Total in a 40 feet container (m)
16009	0.90	0.15 to 1.00	300	13.0	330	99000
16010	1.00	0.15 to 1.00	300	15.0	330	99000
16012	1.20	0.15 to 1.00	300	17.9	330	99000
20010	1.00	0.15 to 1.00	300	18.0	330	99000
20012	1.20	0.15 to 1.00	300	21.5	330	99000

* Calculated weight average. For further details see "Average Coil Weight Disclaimer".

→ **Catalog numbers**

Leach Line™ X 16009

Catalog number 12320 - (any of below 6 digits)

Flow rate (l/h)	Distance between drippers (m)													
	0.15	0.20	0.25	0.30	0.33	0.40	0.50	0.60	0.65	0.70	0.75	0.80	0.90	1.00
1.00				000002			001770							
1.50						001840								
2.00				003160		003150	003320	003370						
4.00						004800	004900			000005	000003	005450	005500	000004
8.00										008000				
Bundled coil length (m)	500	500	500	500	500	500	500	500	500	500	500	500	500	500

Missing catalog numbers available upon request.

Leach Line™ X 16009 with anti-migration assembled clips

Catalog number 12320 - (any of below 6 digits)

Flow rate (l/h)	Distance between drippers (m)													
	0.15	0.20	0.25	0.30	0.33	0.40	0.50	0.60	0.65	0.70	0.75	0.80	0.90	1.00
1.00														
1.50														
2.00							003230	003355						
4.00							000006			000001				
8.00														
Bundled coil length (m)	300	300	300	300	300	300	300	300	300	300	300	300	300	300

Missing catalog numbers available upon request.

Leach Line™ X 16010

Catalog number 12310 - (any of below 6 digits)

Flow rate (l/h)	Distance between drippers (m)													
	0.15	0.20	0.25	0.30	0.33	0.40	0.50	0.60	0.65	0.70	0.75	0.80	0.90	1.00
1.00			001250			001500								
1.50														
2.00						002400	002500	002700						
4.00							003500	003600		003700		003800		
8.00										004680				005100
Bundled coil length (m)	500	500	500	500	500	500	500	500	500	500	500	500	500	500

Missing catalog numbers available upon request.

Leach Line™ X 16010 with anti-migration assembled clips

Catalog number 12310 - (any of below 6 digits)

Flow rate (l/h)	Distance between drippers (m)													
	0.15	0.20	0.25	0.30	0.33	0.40	0.50	0.60	0.65	0.70	0.75	0.80	0.90	1.00
1.00														
1.50														
2.00														
4.00							000006							
8.00														
Bundled coil length (m)	300	300	300	300	300	300	300	300	300	300	300	300	300	300

Missing catalog numbers available upon request.

Leach Line™ X 16012

Catalog number 12300 - (any of below 6 digits)

Flow rate (l/h)	Distance between drippers (m)													
	0.15	0.20	0.25	0.30	0.33	0.40	0.50	0.60	0.65	0.70	0.75	0.80	0.90	1.00
1.05														
1.50														
2.10														
4.20										003930				
8.40										005100				
Bundled coil length (m)	400	400	400	400	400	400	400	400	400	400	400	400	400	400

Missing catalog numbers available upon request.

Leach Line™ X 16012 with anti-migration assembled clips

Catalog number 12300 - (any of below 6 digits)

Flow rate (l/h)	Distance between drippers (m)													
	0.15	0.20	0.25	0.30	0.33	0.40	0.50	0.60	0.65	0.70	0.75	0.80	0.90	1.00
1.05														
1.50														
2.10														
4.20														
8.40														
Bundled coil length (m)	300	300	300	300	300	300	300	300	300	300	300	300	300	300

Missing catalog numbers available upon request.

Leach Line™ X 20010

Catalog number 12400 - (any of below 6 digits)

Flow rate (l/h)	Distance between drippers (m)													
	0.15	0.20	0.25	0.30	0.33	0.40	0.50	0.60	0.65	0.70	0.75	0.80	0.90	1.00
1.00														
1.50														
2.00														
4.00														
8.00												000004	005600	000001
Bundled coil length (m)	300	300	300	300	300	300	300	300	300	300	300	300	300	300

Missing catalog numbers available upon request.

Leach Line™ X 20010 with anti-migration assembled clips

Catalog number 12400 - (any of below 6 digits)

Flow rate (l/h)	Distance between drippers (m)													
	0.15	0.20	0.25	0.30	0.33	0.40	0.50	0.60	0.65	0.70	0.75	0.80	0.90	1.00
1.00														
1.50														
2.00														
4.00														
8.00														
Bundled coil length (m)	300	300	300	300	300	300	300	300	300	300	300	300	300	300

Missing catalog numbers available upon request.

Leach Line™ X 20012

Catalog number 12420 - (any of below 6 digits)

Flow rate (l/h)	Distance between drippers (m)													
	0.15	0.20	0.25	0.30	0.33	0.40	0.50	0.60	0.65	0.70	0.75	0.80	0.90	1.00
1.05														
1.50														
2.10														
4.20														
8.40														000001
Bundled coil length (m)	300	300	300	300	300	300	300	300	300	300	300	300	300	300

Missing catalog numbers available upon request.

Leach Line™ X 20012 with anti-migration assembled clips

Catalog number 12420 - (any of below 6 digits)

Flow rate (l/h)	Distance between drippers (m)													
	0.15	0.20	0.25	0.30	0.33	0.40	0.50	0.60	0.65	0.70	0.75	0.80	0.90	1.00
1.05														
1.50														
2.10														
4.20														
8.40														
Bundled coil length (m)	300	300	300	300	300	300	300	300	300	300	300	300	300	300

Missing catalog numbers available upon request.

Leach Line™ A

Heap leaching dripline.
Integral non-pressure-compensated.
High clogging resistance.

→ 16009 - 16010 - 16012 - 20010 - 20012



High clogging
resistance



Wide filtration
area



Wide water
passages

/ Benefits & Features

- **High clogging resistance** Even with challenging solution quality, with self-cleaning labyrinth that flushes debris throughout operation.
- **Wide filtration area** Ensures optimal performance even under harsh solution conditions, preventing the entrance of sediments into the drippers.
- **Wide water passages** TurbuNext™ labyrinth ensures wide solution passages, large deep and wide cross-section that improves clogging resistance.
- **Anti-migration clip (smart clip)**  Prevents solution migration on uneven surfaces and slopes.
Economical - saves labor. Pre-installed on the dripline during production (optional).

/ Specifications

- Maximum operating pressure according to driplines diameters and wall thickness. See tables below.
- Recommended filtration: 200 micron / 80 mesh. Filtration method selected based on the kind and concentration of dirt particles contained in the solution. Wherever sand exceeding 2 ppm exists in the solution, a Hydrocyclone should be installed before the main filter. Where sand/silt/clay solids exceed 100 ppm, pre treatment it should be applied following Netafim™ expert instructions.
- TurbuNext™ labyrinth with superior performance.
- Weldable into thick wall driplines (0.90, 1.00, 1.20 mm).
- Injected dripper, very low CV.
- High UV resistance. Resistant to chemicals used in heap leaching mines.
- Compliance ISO 9261 international standards.

→ Drippers technical data

16009, 16010, 20010 - 0.9, 1.0 mm wall thickness driplines

Flow rate* (l/h)	Max. working pressure (bar)**	Water passages dimensions width-depth-length (mm)	Filtration area (mm ²)	Constant K	Exponent X	Recommended filtration (micron)/(mesh)
1.00	3.0 / 3.5	0.60 x 0.74 x 65	49	0.347	0.46	200 / 80
1.50		0.71 x 0.85 x 65	53	0.520	0.46	200 / 80
2.00		0.76 x 1.03 x 65	54	0.693	0.46	200 / 80
3.00		0.90 x 1.20 x 65	54	1.040	0.46	200 / 80
4.00		0.94 x 1.28 x 33	54	1.387	0.46	200 / 80
8.00		1.52 x 1.28 x 28	50	2.773	0.46	200 / 80

* Flow rate at 1.0 bar pressure ** According to dripline wall thickness

16012, 20012 - 1.2 mm wall thickness driplines

Flow rate* (l/h)	Max. working pressure (bar)	Water passages dimensions width-depth-length (mm)	Filtration area (mm ²)	Constant K	Exponent X	Recommended filtration (micron)/(mesh)
1.05	4.0	0.60 x 0.74 x 65	49	0.364	0.46	200 / 80
1.60		0.71 x 0.85 x 65	53	0.554	0.46	200 / 80
2.10		0.76 x 1.03 x 65	54	0.728	0.46	200 / 80
3.15		0.90 x 1.20 x 65	54	1.092	0.46	200 / 80
4.20		0.94 x 1.28 x 33	54	1.455	0.46	200 / 80
8.40		1.52 x 1.28 x 28	50	2.912	0.46	200 / 80

* Flow rate at 1.0 bar pressure

→ Driplines technical data

Model	Inside diameter (mm)	Wall thickness (mm)	Outside diameter (mm)	Max. working pressure (bar)	Max. flushing pressure (bar)	KD
16009	14.20	0.90	16.00	3.0	3.9	0.40
16010	14.20	1.00	16.20	3.5	4.6	0.40
16012	14.20	1.20	16.60	4.0	5.2	0.40
20010	17.50	1.00	19.50	3.5	4.6	0.10
20012	17.50	1.20	19.90	4.0	5.2	0.10

→ Driplines packaging data (on bundles coils)

Model	Wall thickness (mm)	Distance between drippers (m)	Coil length (m)	Average* coil weight (kg)	Coils in a 40 feet container (units)	Total in a 40 feet container (m)
16009	0.90	0.15 to 1.00	500	20.7	330	165000
16010	1.00	0.15 to 1.00	500	23.0	330	165000
16012	1.20	0.15 to 1.00	400	22.3	352	140800
20010	1.00	0.15 to 1.00	300	16.7	330	99000
20012	1.20	0.15 to 1.00	300	20.2	330	99000

* Calculated weight average. For further details see "Average Coil Weight Disclaimer".

→ Driplines packaging data (on bundles coils) with assembled anti-migration clips

Model	Wall thickness (mm)	Distance between drippers (m)	Coil length (m)	Average* coil weight (kg)	Coils in a 40 feet container (units)	Total in a 40 feet container (m)
16009	0.90	0.15 to 1.00	300	12.5	330	99000
16010	1.00	0.15 to 1.00	300	14.0	330	99000
16012	1.20	0.15 to 1.00	300	16.9	330	99000
20010	1.00	0.15 to 1.00	300	17.0	330	99000
20012	1.20	0.15 to 1.00	300	20.5	330	99000

* Calculated weight average. For further details see "Average Coil Weight Disclaimer".

→ **Catalog numbers**

Leach Line™ A 16009

Catalog number 12315 - (any of below 6 digits)

Flow rate (l/h)	Distance between drippers (m)													
	0.15	0.20	0.25	0.30	0.33	0.40	0.50	0.60	0.65	0.70	0.75	0.80	0.90	1.00
1.00			000027		000200	000009								
1.50														
2.00						002960	000031	000002			000012			
3.00							000008							
4.00							000026			000014	000003			
8.00														
Bundled coil length (m)	500	500	500	500	500	500	500	500	500	500	500	500	500	500

Missing catalog numbers available upon request.

Leach Line™ A 16009 with anti-migration assembled clips

Catalog number 12315 - (any of below 6 digits)

Flow rate (l/h)	Distance between drippers (m)													
	0.15	0.20	0.25	0.30	0.33	0.40	0.50	0.60	0.65	0.70	0.75	0.80	0.90	1.00
1.00														
1.50														
2.00							002980	003030						
3.00														
4.00														
8.00														
Bundled coil length (m)	300	300	300	300	300	300	300	300	300	300	300	300	300	300

Missing catalog numbers available upon request.

Leach Line™ A 16010

Catalog number 12308 - (any of below 6 digits)

Flow rate (l/h)	Distance between drippers (m)													
	0.15	0.20	0.25	0.30	0.33	0.40	0.50	0.60	0.65	0.70	0.75	0.80	0.90	1.00
1.00			000002			000012								
1.50						000016			001856					
2.00				001990	002010		002050							
3.00							000029							
4.00						000052	000030	005310	000028	005320				
8.00														
Bundled coil length (m)	500	500	500	500	500	500	500	500	500	500	500	500	500	500

Missing catalog numbers available upon request.

Leach Line™ A 16010 with anti-migration assembled clips

Catalog number 12308 - (any of below 6 digits)

Flow rate (l/h)	Distance between drippers (m)													
	0.15	0.20	0.25	0.30	0.33	0.40	0.50	0.60	0.65	0.70	0.75	0.80	0.90	1.00
1.00					000047	000990								
1.50						000014								
2.00							000006							
3.00														
4.00														
8.00														
Bundled coil length (m)	300	300	300	300	300	300	300	300	300	300	300	300	300	300

Missing catalog numbers available upon request.

Leach Line™ A 16012

Catalog number 12290 - (any of below 6 digits)

Flow rate (l/h)	Distance between drippers (m)													
	0.15	0.20	0.25	0.30	0.33	0.40	0.50	0.60	0.65	0.70	0.75	0.80	0.90	1.00
1.05							000009	000008						
1.60														
2.10														
3.15							000021							
4.20								000005		000002				
8.40														
Bundled coil length (m)	400	400	400	400	400	400	400	400	400	400	400	400	400	400

Missing catalog numbers available upon request.

Leach Line™ A 16012 with anti-migration assembled clips

Catalog number 12290 - (any of below 6 digits)

Flow rate (l/h)	Distance between drippers (m)													
	0.15	0.20	0.25	0.30	0.33	0.40	0.50	0.60	0.65	0.70	0.75	0.80	0.90	1.00
1.05														
1.60						001900								
2.10														
3.15														
4.20							000014			005990				
8.40														
Bundled coil length (m)	300	300	300	300	300	300	300	300	300	300	300	300	300	300

Missing catalog numbers available upon request.

Leach Line™ A 20010

Catalog number 12379 - (any of below 6 digits)

Flow rate (l/h)	Distance between drippers (m)													
	0.15	0.20	0.25	0.30	0.33	0.40	0.50	0.60	0.65	0.70	0.75	0.80	0.90	1.00
1.00														
1.50														
2.00														
3.00														
4.00														
8.00														
Bundled coil length (m)	300	300	300	300	300	300	300	300	300	300	300	300	300	300

Missing catalog numbers available upon request.

Leach Line™ A 20010 with anti-migration assembled clips

Catalog number 12379 - (any of below 6 digits)

Flow rate (l/h)	Distance between drippers (m)													
	0.15	0.20	0.25	0.30	0.33	0.40	0.50	0.60	0.65	0.70	0.75	0.80	0.90	1.00
1.00														
1.50														
2.00														
3.00														
4.00														
8.00														
Bundled coil length (m)	300	300	300	300	300	300	300	300	300	300	300	300	300	300

Missing catalog numbers available upon request.

Leach Line™ A 20012

Catalog number 12380 - (any of below 6 digits)

Flow rate (l/h)	Distance between drippers (m)													
	0.15	0.20	0.25	0.30	0.33	0.40	0.50	0.60	0.65	0.70	0.75	0.80	0.90	1.00
1.05														
1.60														
2.10														
3.15														
4.20														
8.40														
Bundled coil length (m)	300	300	300	300	300	300	300	300	300	300	300	300	300	300

Missing catalog numbers available upon request.

Leach Line™ A 20012 with anti-migration assembled clips

Catalog number 12380 - (any of below 6 digits)

Flow rate (l/h)	Distance between drippers (m)													
	0.15	0.20	0.25	0.30	0.33	0.40	0.50	0.60	0.65	0.70	0.75	0.80	0.90	1.00
1.05														
1.60														
2.10														
3.15														
4.20														
8.40														
Bundled coil length (m)	300	300	300	300	300	300	300	300	300	300	300	300	300	300

Missing catalog numbers available upon request.

Leach Line™ U

Heap leaching dripline, mainly for slopes in gold and silver mine leaching. Integral pressure-compensated. Superior uniform flow in slopes.

→ 16009 - 16010 - 16012 - 20010 - 20012



Pressure-compensated



Self-flushing mechanism



Anti-migration mechanism (optional)

/ Benefits & Features

- Pressure-compensated
Precise and equal amounts of solution delivered over a broad pressure range, ensuring 100% uniformity of water and chemicals distribution along the laterals.
- Continuously self-flushing
Flushes debris throughout operation, while ensuring constant dripper operation even in challenging solution quality.
- Anti-migration clip (smart clip)
 Prevents solution migration on uneven surfaces and slopes. Economical - saves labor. Pre-installed on the dripline during production (optional).
- Wide filtration area
Ensures optimal performance even under harsh solution conditions, preventing the entrance of sediment into the labyrinths.
- Wide water passages
TurboNet™ labyrinth ensures wide solution passages, large deep and wide cross-section that improves clogging resistance. The solution is drawn into the dripper from the stream center, preventing the entrance of sediment into the drippers.

/ Specifications

- Pressure-compensated range: 0.5 - 4.0 bar.
- Recommended filtration: depending on dripper flow rate. Filtration method selected based on the kind and concentration of dirt particles contained in the solution. Wherever sand exceeding 2 ppm exists in the solution, a Hydrocyclone should be installed before the main filter. Where sand/silt/clay solids exceed 100 ppm, pre treatment it should be applied following Netafim™ expert instructions.
- Double TurboNet™ labyrinth with large water passage.
- Weldable into thick wall driplines (0.90, 1.00, 1.20 mm).
- Injected dripper, very low CV with injected silicon diaphragm.
- High UV resistant. Resistant to chemicals used in heap leaching gold and silver mines.
- Compliance ISO 9261 international standards.

→ **Drippers technical data**

Flow rate* (l/h)	Working pressure range (bar)	Water passages dimensions width-depth-length (mm)	Filtration area (mm ²)	Constant K	Exponent* X	Recommended filtration (micron)/(mesh)
0.70	0.5 - 4.0	0.70 x 0.65 x 40	110	0.7	0	130/120
1.00		0.83 x 0.74 x 40	130	1.0	0	130/120
1.60		1.09 x 0.46 x 40	130	1.6	0	200/80
2.30		1.26 x 0.93 x 40	130	2.3	0	200/80
3.50		1.59 x 1.07 x 40	150	3.5	0	200/80

* Within working pressure range

→ **Driplines technical data**

Model	Inside diameter (mm)	Wall thickness (mm)	Outside diameter (mm)	Max. working pressure (bar)	Max. flushing pressure (bar)	KD
16009	14.20	0.90	16.00	3.0	3.9	1.30
16010	14.20	1.00	16.20	3.5	4.6	1.30
16012	14.20	1.20	16.60	4.0	5.2	1.30
20010	17.50	1.00	19.50	3.5	4.6	0.40
20012	17.50	1.20	19.90	4.0	5.2	0.40

→ **Driplines packaging data (on bundles coils)**

Model	Wall thickness (mm)	Distance between drippers (m)	Coil length (m)	Average* coil weight (kg)	Coils in a 40 feet container (units)	Total in a 40 feet container (m)
16009	0.90	0.15 to 1.00	500	20.3	330	165000
16010	1.00	0.15 to 1.00	500	22.1	330	165000
16012	1.20	0.15 to 1.00	400	21.2	352	140800
20010	1.00	0.15 to 1.00	300	17.4	330	99000
20012	1.20	0.15 to 1.00	300	20.2	330	99000

* Calculated weight average. For further details see "Average Coil Weight Disclaimer".

→ **Driplines packaging data (on bundles coils) with anti-migration assembled clips**

Model	Wall thickness (mm)	Distance between drippers (m)	Coil length (m)	Average* coil weight (kg)	Coils in a 40 feet container (units)	Total in a 40 feet container (m)
16009	0.90	0.15 to 1.00	300	13.3	330	99000
16010	1.00	0.15 to 1.00	300	13.5	330	99000
16012	1.20	0.15 to 1.00	300	16.1	330	99000
20010	1.00	0.15 to 1.00	300	16.3	330	99000
20012	1.20	0.15 to 1.00	300	19.3	330	99000

* Calculated weight average. For further details see "Average Coil Weight Disclaimer".

→ **Catalog numbers**

Leach Line™ U 16009

Catalog number 12326 - (any of below 6 digits)

Flow rate (l/h)	Distance between drippers (m)													
	0.15	0.20	0.25	0.30	0.33	0.40	0.50	0.60	0.65	0.70	0.75	0.80	0.90	1.00
0.70														
1.00														
1.60														
2.30														
3.50														
Bundled coil length (m)	500	500	500	500	500	500	500	500	500	500	500	500	500	500

Missing catalog numbers available upon request.

Leach Line™ U 16009 with anti-migration assembled clips

Catalog number 12326 - (any of below 6 digits)

Flow rate (l/h)	Distance between drippers (m)													
	0.15	0.20	0.25	0.30	0.33	0.40	0.50	0.60	0.65	0.70	0.75	0.80	0.90	1.00
0.70														
1.00														
1.60								000001						
2.30														
3.50						000003	000002							
Bundled coil length (m)	300	300	300	300	300	300	300	300	300	300	300	300	300	300

Missing catalog numbers available upon request.

Leach Line™ U 16010

Catalog number 12311 - (any of below 6 digits)

Flow rate (l/h)	Distance between drippers (m)													
	0.15	0.20	0.25	0.30	0.33	0.40	0.50	0.60	0.65	0.70	0.75	0.80	0.90	1.00
0.70														
1.00														
1.60														
2.30														
3.50														
Bundled coil length (m)	500	500	500	500	500	500	500	500	500	500	500	500	500	500

Missing catalog numbers available upon request.

Leach Line™ U 16010 with anti-migration assembled clips

Catalog number 12311 - (any of below 6 digits)

Flow rate (l/h)	Distance between drippers (m)													
	0.15	0.20	0.25	0.30	0.33	0.40	0.50	0.60	0.65	0.70	0.75	0.80	0.90	1.00
0.70														
1.00														
1.60														
2.30								000002						
3.50						000004								
Bundled coil length (m)	300	300	300	300	300	300	300	300	300	300	300	300	300	300

Missing catalog numbers available upon request.

Leach Line™ U 16012

Catalog number 12285 - (any of below 6 digits)

Flow rate (l/h)	Distance between drippers (m)													
	0.15	0.20	0.25	0.30	0.33	0.40	0.50	0.60	0.65	0.70	0.75	0.80	0.90	1.00
0.70														
1.00														
1.60							000002							
2.30														
3.50														
Bundled coil length (m)	400	400	400	400	400	400	400	400	400	400	400	400	400	400

Missing catalog numbers available upon request.

Leach Line™ U 16012 with anti-migration assembled clips

Catalog number 12285 - (any of below 6 digits)

Flow rate (l/h)	Distance between drippers (m)													
	0.15	0.20	0.25	0.30	0.33	0.40	0.50	0.60	0.65	0.70	0.75	0.80	0.90	1.00
0.70														
1.00														
1.60														
2.30														
3.50												000006		
Bundled coil length (m)	300	300	300	300	300	300	300	300	300	300	300	300	300	300

Missing catalog numbers available upon request.

Leach Line™ U 20010

Catalog number 12422 - (any of below 6 digits)

Flow rate (l/h)	Distance between drippers (m)													
	0.15	0.20	0.25	0.30	0.33	0.40	0.50	0.60	0.65	0.70	0.75	0.80	0.90	1.00
0.70														
1.00														
1.60														
2.30														
3.50														
Bundled coil length (m)	300	300	300	300	300	300	300	300	300	300	300	300	300	300

Missing catalog numbers available upon request.

Leach Line™ U 20010 with anti-migration assembled clips

Catalog number 12422 - (any of below 6 digits)

Flow rate (l/h)	Distance between drippers (m)													
	0.15	0.20	0.25	0.30	0.33	0.40	0.50	0.60	0.65	0.70	0.75	0.80	0.90	1.00
0.70														
1.00														
1.60								000001						
2.30														
3.50														
Bundled coil length (m)	300	300	300	300	300	300	300	300	300	300	300	300	300	300

Missing catalog numbers available upon request.

Leach Line™ U 20012

Catalog number 12423 - (any of below 6 digits)

Flow rate (l/h)	Distance between drippers (m)													
	0.15	0.20	0.25	0.30	0.33	0.40	0.50	0.60	0.65	0.70	0.75	0.80	0.90	1.00
0.70														
1.00														
1.60														
2.30														
3.50														
Bundled coil length (m)	300	300	300	300	300	300	300	300	300	300	300	300	300	300

Missing catalog numbers available upon request.

Leach Line™ U 20012 with anti-migration assembled clips

Catalog number 12423 - (any of below 6 digits)

Flow rate (l/h)	Distance between drippers (m)													
	0.15	0.20	0.25	0.30	0.33	0.40	0.50	0.60	0.65	0.70	0.75	0.80	0.90	1.00
0.70														
1.00														
1.60								000001						
2.30														
3.50														
Bundled coil length (m)	300	300	300	300	300	300	300	300	300	300	300	300	300	300

Missing catalog numbers available upon request.

Leach Line™ D

Heap leaching dripline, mainly for slopes in gold and silver mine leaching. Integral pressure-compensated. Superior uniform flow in slopes.

→ 16009 - 16010 - 16012 - 20010 - 20012

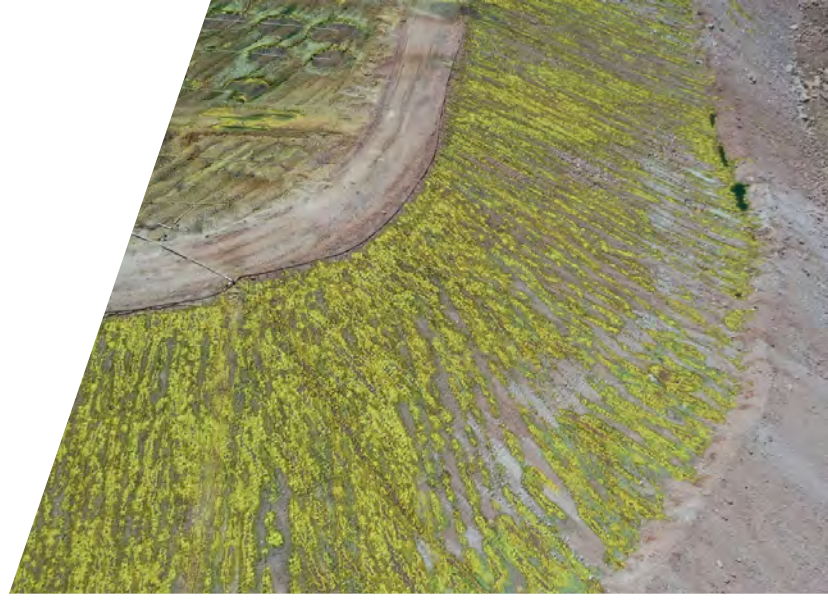

Pressure-compensated



Self-flushing mechanism



Anti-migration mechanism (optional)

/ Benefits & Features

- **Pressure-compensated** Precise and equal amounts of solution delivered over a broad pressure range, ensuring 100% uniformity of water and chemicals distribution along the laterals.
- **Continuously self-flushing** Flushes debris throughout operation, while ensuring constant dripper operation even in challenging water quality.
- **Anti-migration clip (smart clip)**  Prevents solution migration on uneven surfaces and slopes. Economical - saves labor. Pre-installed on the dripline during production (optional).
- **Wide filtration area** Ensures optimal performance even under harsh solution conditions, preventing the entrance of sediment into the labyrinths.
- **Wide water passages** TurboNet™ labyrinth ensures wide solution passages, large deep and wide cross-section that improves clogging resistance. The solution is drawn into the dripper from the stream center, preventing the entrance of sediment into the drippers.

/ Specifications

- Pressure-compensated range according to table below.
- Recommended filtration: depending on dripper flow rate. Filtration method selected based on the kind and concentration of dirt particles contained in the solution. Wherever sand exceeding 2 ppm exists in the solution, a Hydrocyclone should be installed before the main filter. Where sand/silt/clay solids exceed 100 ppm, pre treatment it should be applied following Netafim™ expert instructions.
- TurboNet™ labyrinth with large water passage.
- Weldable into thick wall driplines (0.90, 1.00, 1.20 mm).
- Injected dripper, very low CV with injected silicon diaphragm.
- High UV resistant. Resistant to chemicals used in heap leaching gold and silver mines.
- Compliance ISO 9261 international standards.

→ Drippers technical data

Flow rate* (l/h)	Working pressure range (bar)	Water passages dimensions width-depth-length (mm)	Filtration area (mm ²)	Constant K	Exponent* X	Recommended filtration (micron)/(mesh)
1.00	0.40 - 3.0	0.61 x 0.60 x 8	39	1.0	0	130/120
1.60	0.40 - 3.0	0.76 x 0.73 x 8	39	1.6	0	200/80
2.00	0.40 - 3.5	0.76 x 0.88 x 8	39	2.0	0	200/80
3.00	0.40 - 3.5	1.02 x 0.88 x 8	39	3.0	0	200/80
3.50	0.60 - 3.5	1.02 x 0.88 x 8	39	3.5	0	200/80
3.80	0.60 - 3.5	1.02 x 0.88 x 8	39	3.8	0	200/80

* Within working pressure range

→ Driplines technical data

Model	Inside diameter (mm)	Wall thickness (mm)	Outside diameter (mm)	Max. working pressure (bar)	Max. flushing pressure (bar)	KD
16009	14.20	0.90	16.00	2.5/3.0/3.5*	3.9	0.72
16010	14.20	1.00	16.20	2.5/3.0/3.5*	4.6	0.72
16012	14.20	1.20	16.60	2.5/3.0/3.5*	5.2	0.72
20010	17.50	1.00	19.50	2.5/3.0/3.5*	4.6	0.25
20012	17.50	1.20	19.90	2.5/3.0/3.5*	5.2	0.25

* The maximum working pressure is defined by the dripper or by the dripline wall thickness

→ Driplines packaging data (on bundles coils)

Model	Wall thickness (mm)	Distance between drippers (m)	Coil length (m)	Average* coil weight (kg)	Coils in a 40 feet container (units)	Total in a 40 feet container (m)
16009	0.90	0.15 to 1.00	500	18.5	330	165000
16010	1.00	0.15 to 1.00	500	20.4	330	165000
16012	1.20	0.15 to 1.00	400	22.4	352	140800
20010	1.00	0.15 to 1.00	300	16.8	330	99000
20012	1.20	0.15 to 1.00	300	20.3	330	99000

* Calculated weight average. For further details see "Average Coil Weight Disclaimer".

→ Driplines packaging data (on bundles coils) with anti-migration assembled clips

Model	Wall thickness (mm)	Distance between drippers (m)	Coil length (m)	Average* coil weight (kg)	Coils in a 40 feet container (units)	Total in a 40 feet container (m)
16009	0.90	0.15 to 1.00	300	13.3	330	99000
16010	1.00	0.15 to 1.00	300	13.5	330	99000
16012	1.20	0.15 to 1.00	300	16.1	330	99000
20010	1.00	0.15 to 1.00	300	16.3	330	99000
20012	1.20	0.15 to 1.00	300	19.3	330	99000

* Calculated weight average. For further details see "Average Coil Weight Disclaimer".

→ Catalog numbers

Leach Line™ D 16009

Catalog number 12325 - (any of below 6 digits)

Flow rate (l/h)	Distance between drippers (m)													
	0.15	0.20	0.25	0.30	0.33	0.40	0.50	0.60	0.65	0.70	0.75	0.80	0.90	1.00
1.00														
1.60														
2.00							000005							
3.00														
3.50														
3.80														
Bundled coil length (m)	500	500	500	500	500	500	500	500	500	500	500	500	500	500

Missing catalog numbers available upon request.

Leach Line™ D 16009 with anti-migration assembled clips

Catalog number 12325 - (any of below 6 digits)

Flow rate (l/h)	Distance between drippers (m)													
	0.15	0.20	0.25	0.30	0.33	0.40	0.50	0.60	0.65	0.70	0.75	0.80	0.90	1.00
1.00														
1.60							000001	000006						
2.00						003010						000004		
3.00														
3.50							000010							
3.80						000007	005000							
Bundled coil length (m)	300	300	300	300	300	300	300	300	300	300	300	300	300	300

Missing catalog numbers available upon request.

Leach Line™ D 16010

Catalog number 12309 - (any of below 6 digits)

Flow rate (l/h)	Distance between drippers (m)													
	0.15	0.20	0.25	0.30	0.33	0.40	0.50	0.60	0.65	0.70	0.75	0.80	0.90	1.00
1.00														
1.60														
2.00														
3.00														
3.50														
3.80														
Bundled coil length (m)	500	500	500	500	500	500	500	500	500	500	500	500	500	500

Missing catalog numbers available upon request.

Leach Line™ D 16010 with anti-migration assembled clips

Catalog number 12309 - (any of below 6 digits)

Flow rate (l/h)	Distance between drippers (m)													
	0.15	0.20	0.25	0.30	0.33	0.40	0.50	0.60	0.65	0.70	0.75	0.80	0.90	1.00
1.00														
1.60						000001								
2.00								000005						
3.00														
3.50														
3.80														
Bundled coil length (m)	300	300	300	300	300	300	300	300	300	300	300	300	300	300

Missing catalog numbers available upon request.

Leach Line™ D 16012

Catalog number 12424 - (any of below 6 digits)

Flow rate (l/h)	Distance between drippers (m)													
	0.15	0.20	0.25	0.30	0.33	0.40	0.50	0.60	0.65	0.70	0.75	0.80	0.90	1.00
1.00														
1.60														
2.00														
3.00														
3.50														
3.80														
Bundled coil length (m)	400	400	400	400	400	400	400	400	400	400	400	400	400	400

Missing catalog numbers available upon request.

Leach Line™ D 16012 with anti-migration assembled clips

Catalog number 12424 - (any of below 6 digits)

Flow rate (l/h)	Distance between drippers (m)													
	0.15	0.20	0.25	0.30	0.33	0.40	0.50	0.60	0.65	0.70	0.75	0.80	0.90	1.00
1.00														
1.60								000001						
2.00														
3.00														
3.50														
3.80														
Bundled coil length (m)	300	300	300	300	300	300	300	300	300	300	300	300	300	300

Missing catalog numbers available upon request.

Leach Line™ D 20010

Catalog number 12425 - (any of below 6 digits)

Flow rate (l/h)	Distance between drippers (m)													
	0.15	0.20	0.25	0.30	0.33	0.40	0.50	0.60	0.65	0.70	0.75	0.80	0.90	1.00
1.00														
1.60														
2.00														
3.00														
3.50														
3.80														
Bundled coil length (m)	300	300	300	300	300	300	300	300	300	300	300	300	300	300

Missing catalog numbers available upon request.

Leach Line™ D 20010 with anti-migration assembled clips

Catalog number 12425 - (any of below 6 digits)

Flow rate (l/h)	Distance between drippers (m)													
	0.15	0.20	0.25	0.30	0.33	0.40	0.50	0.60	0.65	0.70	0.75	0.80	0.90	1.00
1.00														
1.60								000001						
2.00														
3.00														
3.50														
3.80														
Bundled coil length (m)	300	300	300	300	300	300	300	300	300	300	300	300	300	300

Missing catalog numbers available upon request.

Leach Line™ D 20012

Catalog number 12426 - (any of below 6 digits)

Flow rate (l/h)	Distance between drippers (m)													
	0.15	0.20	0.25	0.30	0.33	0.40	0.50	0.60	0.65	0.70	0.75	0.80	0.90	1.00
1.00														
1.60														
2.00														
3.00														
3.50														
3.80														
Bundled coil length (m)	300	300	300	300	300	300	300	300	300	300	300	300	300	300

Missing catalog numbers available upon request.

Leach Line™ D 20012 with anti-migration assembled clips

Catalog number 12426 - (any of below 6 digits)

Flow rate (l/h)	Distance between drippers (m)													
	0.15	0.20	0.25	0.30	0.33	0.40	0.50	0.60	0.65	0.70	0.75	0.80	0.90	1.00
1.00														
1.60								000001						
2.00														
3.00														
3.50														
3.80														
Bundled coil length (m)	300	300	300	300	300	300	300	300	300	300	300	300	300	300

Missing catalog numbers available upon request.

Sprinklers



GyroNet™ Turbo

For heap leaching, copper, gold and silver mines, sprinkler spacing up to 7x7 meter, it is the ultimate full-coverage midi-sprinkler. Expect highly uniform coverage with high precipitation rates and very gentle droplet size.

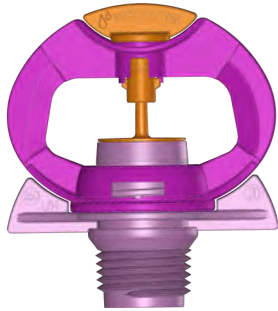

Superb quality



High durability



Superb uniformity

/ Benefits & Features

- **Highly resistant** Excellent resistance against clogging, chemicals and acids, keeps maintenance and repair costs to a minimum. The components of the sprinkler are produced from special raw materials makes it more resistant to high concentration of acids might be used in mines.
- **High-performance** Sprinkler longevity assured thanks to wear-resistant EverSpin™ upper bearing made from Sapphire stone.
- **Uniform distribution** Innovative water channels and specially shaped bridges ensure superbly uniform water distribution and coverage across the heap.
- **Easy maintenance** Pop-up mechanism opened only during operation, eliminating the need for flushing.
- **Optimal drop size** Perfectly balanced for relative long distances with high distribution uniformity.

/ Specifications

- 5 different flow rates: 200, 250, 300, 400, 500 l/h.
- Nominal flow rate at: 2.2 bar.
- Recommended pressure range: 2.0 - 3.0 b bar.
- Gyronet™ Turbo can work with 1.5 bar minimum pressure and supply high uniformity of watering profile.
- Inlet connector: 1/2" male threaded.
- EverSpin™ bearing including sapphire for wear resistance.
- Recommended filtration*: 130 micron / 120 mesh.

*Note: Filtration method selected based on the kind and concentration of dirt particles contained in the solution. Wherever sand exceeding 2 ppm exists in the solution, a Hydrocyclone should be installed before the main filter. Where sand/silt/clay solids exceed 100 ppm, pre treatment it should be applied following Netafim™ expert instructions.

→ Technical data

Model	Nozzle color	Nozzle diameter (mm)	Max. working pressure (bar)	Constant K	Exponent X	Wetted diameter at 0.5 m height (m)	Swivel color
200	Black	1.89	3.0	42.5	0.5	8.5	Orange
250	Light Purple	2.14		54.5		10.0	
300	Black	2.31		64.1		10.5	
400	Black	2.67		86.8		11.0	
500	Black	3.00		108.5		11.5	

→ Flow rate (l/h) vs pressure (bar)

Model	Working pressure (bar)			
	1.5	2.0	2.5	3.0
200	165	190	213	233
250	211	244	273	299
300	248	287	321	351
400	336	388	434	475
500	420	485	543	594

→ Performance data

Model	Nozzle color code	Rotor color code	Working pressure (bar)	Height above soil (m)	Distance between emitters (m)	Distance between laterals (m)	Cu	Du	Sc (5%)	Prepcipation (l/m ² /h)
200	Black	Orange	1.5	0.5	3.0	3.0	95%	91%	1.2	15.6
					3.5	3.5	93%	87%	1.4	11.4
					4.0	4.0	87%	81%	1.3	8.8
			4.0		4.0	96%	95%	1.1	11.6	
			4.5		4.5	93%	89%	1.2	9.2	
			5.0		5.0	94%	91%	1.1	7.5	
250	Light Purple		1.5	0.5	3.5	3.0	96%	94%	1.1	17.1
					4.0	3.5	96%	94%	1.1	13.1
					4.5	4.0	90%	87%	1.2	10.4
			4.0		4.0	95%	92%	1.1	13.5	
			4.5		4.5	92%	87%	1.2	10.6	
			5.0		5.0	93%	90%	1.2	8.6	
300	Black	1.5	0.5	5.0	5.0	90%	86%	1.4	9.8	
				5.5	5.5	92%	87%	1.3	8.1	
				6.0	6.0	90%	87%	1.2	6.8	
		4.5		4.5	94%	93%	1.1	14.0		
		5.0		5.0	93%	89%	1.2	11.3		
		5.5		5.5	92%	88%	1.2	9.3		
400	Black	1.5	0.5	6.0	6.0	90%	84%	1.4	9.3	
				6.5	6.5	93%	90%	1.2	7.9	
				7.0	7.0	91%	85%	1.2	6.8	
		6.0		6.0	92%	87%	1.2	10.3		
		6.5		6.5	95%	93%	1.1	8.8		
		7.0		7.0	92%	88%	1.1	7.6		
500	Black	1.5	0.5	6.5	6.5	89%	84%	1.5	9.9	
				7.0	7.0	92%	86%	1.2	8.5	
				7.5	7.5	89%	85%	1.2	7.4	
		6.5		6.5	93%	92%	1.1	11.3		
		7.0		7.0	92%	91%	1.1	9.8		
		7.5		7.5	87%	82%	1.2	8.5		

→ **Catalog numbers**

Description	Catalog number
Gyr trb lr 1/2ic 200l/h head only for mine	64100-001900
Gyr trb lr 1/2ic 250l/h head only for mine	64100-003040
Gyr trb lr 1/2ic 300l/h head only for mine	64100-003900
Gyr trb lr 1/2ic 400l/h head only for mine	64100-005000
Gyr trb lr 1/2ic 500l/h head only for mine	64100-005980

→ **The GyroNet™ Turbo structure**

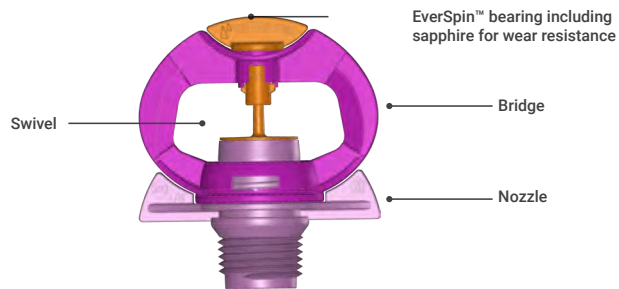

MegaNet™

Innovative fortress impact sprinkler with twin jet design, MegaNet™ delivers highly uniform water distribution ideally suited to heap leaching in gold and silver mines up to 10x10 meters spacing.



Superb
uniformity



Wide filtration
area



High
durability

/ Benefits & Features

- **Uniform distribution** A unique symmetrical structure splits water into two equal jets creating a more balanced distribution of water.
- **High clogging resistance** MegaNet's one-of-a-kind built-in filter protects the sprinkler nozzle from becoming clogged with debris, reducing repair and maintenance costs.
- **Double-damage protection** Unique pop-up mechanism that opens only during watering.
- **Suitable for sloping heaps** Well suited for sloping heap topologies - easy to install with excellent coverage.

/ Specifications

- 7 different flow rates: 200, 250, 350, 450, 550, 650, 750 l/h.
- Nominal flow rate at: 2.3 bar.
- Recommended pressure range: 2.0 - 3.0 bar.
- Water trajectory angle: 15 or 24 degrees.
- Nozzle protection: Integral filter at the inlet of the sprinkler.
- Water distribution using a special rotating turbine and two identical symmetrical nozzles.
- Inlet connectors: 1/2" male threaded.
- Color coded for easy identification: Cap is color coded according to the flow rate. Locking pin for 15D model is white, for 24D model is black.
- Made of UV-protected materials, durable to all climate conditions and chemicals injected in gold and silver mines.
- Compliance ISO 8026 international standards.
- Recommended filtration*: 400 micron / 40 mesh.

*Note: Filtration method selected based on the kind and concentration of dirt particles contained in the solution. Wherever sand exceeding 2 ppm exists in the solution, a Hydrocyclone should be installed before the main filter. Where sand/silt/clay solids exceed 100 ppm, pre treatment it should be applied following Netafim™ expert instructions.

→ Technical data

Model	Nozzle color	Nozzle size (mm)	Max. working pressure (bar)	Constant K	Exponent X	MegaNet 15D wetted diameter at 0.5 m height (m)	MegaNet 24D wetted diameter at 0.5 m height (m)
200	Yellow	1.85	3.0	42.0	0.5	14.0	11.0
250	Purple	2.06		51.6			102.0
350	Green	2.44		72.3			14.0
450	Blue	2.79		92.2		16.0	17.0
550	Brown	3.08		110.5			18.0
650	Orange	3.37		135.6			
750	Red	2.68		157.0		17.0	

→ Flow rate (l/h) vs pressure (bar)

Model	2.0	2.5	3.0
200	163	188	230
250	200	231	283
350	280	323	396
450	357	412	505
550	428	494	605
650	525	606	743
750	608	702	860

→ Catalog numbers

Model	MegaNet™ 15D ½" threaded inlet connector	MegaNet™ 24D ½" threaded inlet connector
200	63600-004900	63600-001700
250	63600-004950	63600-001750
350	63600-005000	63600-001000
450	63600-006000	63600-002000
550	63600-007000	63600-003000
650	63600-008000	63600-004000
750	63600-009000	63600-004500

→ MegaNet™ 15D performance data

Nozzle size (mm)	Color code	Working pressure (bar)	Flow rate (l/h)	Watted diameter* (m)	Precipitation (mm/h)						
					Spacing (m x m)						
					7 x 8	8 x 8	8 x 10	9 x 9	10 x 10	10 x 11	10 x 12
1.85	Yellow	2.5	210	14.0	3.8	3.3	2.6	2.6	2.1	1.9	1.8
		3.0	230		4.1	3.6	2.9	2.8	2.3	2.1	1.9
2.06	Purple	2.5	258		4.6	4.0	3.2	3.2	2.6	2.3	2.2
		3.0	283		5.1	4.4	3.5	3.5	2.8	2.6	2.4
2.44	Green	2.5	362		6.5	5.7	4.5	4.5	3.6	3.3	3.0
		3.0	396		7.1	6.2	5.0	4.9	4.0	3.6	3.3
2.79	Blue	2.5	461	16.0	8.2	7.2	5.8	5.7	4.6	4.2	3.8
		3.0	505		9.0	7.9	6.3	6.2	5.1	4.6	4.2
3.08	Brown	2.5	553		9.9	8.6	6.9	6.8	5.5	5.0	4.6
		3.0	605		10.8	9.5	7.6	7.5	6.1	5.5	5.0
3.37	Orange	2.5	678		12.1	10.6	8.5	8.4	6.8	6.2	5.7
		3.0	743		13.3	11.6	9.3	9.2	7.4	6.8	6.2
3.68	Red	2.5	785	17.0	14.0	12.3	9.8	9.7	7.9	7.1	6.5
		3.0	860		15.4	13.4	10.8	10.6	8.6	7.8	7.2

* at least 0.5 mm/h

** Performance table prepared under laboratory conditions, sprinkler head 1.0 meter above ground

→ MegaNet™ 24D performance data

Nozzle size (mm)	Color code	Working pressure (bar)	Flow rate (l/h)	Watted diameter* (m)	Precipitation (mm/h)							
					Spacing (m x m)							
					7 x 8	8 x 8	8 x 10	9 x 9	10 x 10	10 x 11	10 x 12	
1.85	Yellow	2.5	210	11.0	3.6	3.3						
		3.0	230		3.8	3.6						
2.06	Purple	2.5	258	12.0	4.4	4.0						
		3.0	283		4.8	4.4						
2.44	Green	2.5	362	14.0	5.9	5.6	4.5	4.4	3.6			
		3.0	396		6.5	6.2	5.0	4.9	4.0			
2.79	Blue	2.5	461	17.0	8.1	7.2	5.8	5.7	4.6	4.2	3.9	
		3.0	505		8.7	7.9	6.3	6.2	5.0	4.6	4.2	
3.08	Brown	2.5	553	18.0	10.0	8.6	6.9	7.2	5.5	5.0	4.6	
		3.0	605		10.1	9.5	7.6	7.5	6.1	5.5	5.1	
3.37	Orange	2.5	678	18.0	11.5	10.6	8.5	8.4	6.8	6.2	5.7	
		3.0	743		12.3	11.6	9.3	9.2	7.4	6.8	6.2	
3.68	Red	2.5	785	19.0	13.4	12.3	9.8	9.7	7.9	7.1	6.6	
		3.0	860		15.0	13.4	10.7	10.6	8.6	7.8	7.2	

* at least 0.5 mm/h

** Performance table prepared under laboratory conditions, sprinkler head 1.0 meter above ground

MegaStand™

Sprinkler stands designed to provide robust sprinkler operation in mining environments, particularly over heat-leaching pads. They enable easy installation with Netafim™ flexible pipes.



Labor saving



Flexible location



High durability

/ Benefits & Features

- **Labor saving** Easy to install and collect. Suitable for a combination between GyroNet™ Turbo or MegaNet™ (with male thread inlet connector ½") and flexible pipes: FlexNet™ HP.
- **Flexible** MegaStand™, with his flexible installation heights, is the ultimate solution for overhead irrigation over heat-leaching pads.
- **High durability** Made from acid-resisting materials, suitable for multiple leaching of minerals.

→ Components catalog numbers and packaging data

Illustration	Description	Catalog number	Quantity p/box (units)	Box size (cm x cm x cm)	Box weight (kg)
	Mega-riser 1/2" 0.4 meter length ½" male threaded - ½" female threaded	64520-002480	100	55 x 37 x 30	6.5
	Mega supporting arm	64520-002485	50	55 x 37 x 30	9.1
	Mega-base	64520-002490	25	43 x 29 x 28	11.8

MegaStand™ floating base

Upgrade to an optimal floating evaporation system with top-tier components to maximize performance. Netafim™ solution ensures peak evaporation efficiency, minimizing labor costs and maximizing hydraulic performance for comprehensive coverage across ponds.



/ Benefits & Features

- **Easy installation** No need for special tools.
- **Safe operation** Effective treatment of mining waste water products.
- **Robust** High resistance to chemicals and U.V.
- **Cost effective** Low maintenance and running costs.

/ Specifications

- To be used together with MegaStand™ components.

→ Packing data

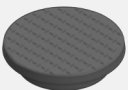
Illustration	Model	Quantity per pallet (units)	Unite size	Unit weight (kg)	Catalog number
	Mega float base for MegaStand™ mine	40	65 cm Dia 15 cm Hight	6	005300-64520

Pipes



FlexNet™ HP

Innovative main line and distribution piping solutions that are easy to install.
Fully adjusted to heap leaching applications.
High environmental resistance and easy recoil, and relocate.



User friendly



Superb uniformity



High durability

/ Benefits & Features

- **Easy to use** Simple, fast installation and retrieval, thanks to low product weight, pre-order welded outlets with spacing tailored to the pad needs, and specially designed dripline connectors that require no glue or Teflon.
- **Uniform performance** Sealed outlets ensure uniform irrigation, maintain uniform percolation of the solution through the pad, and increase mineral extraction efficiency.
- **High-level resistance** White color provides high thermal resistance, chemical resistance, and UV resistance.
- **Snaking-free** Driplines remain in the same position throughout the entire season due to avoidance of the "snaking" phenomenon prevalent in other sub-main pipes in the market.
- **Repeated usage** Unique weaving provides both strength and lightness, enabling multiple installations and retrievals.
- **Long-lasting** Full suite of auxiliary products ensures simple connectivity and maintenance, guaranteeing extended product performance.

/ Specifications

- Compliance ISO 16438 international standards.
- Available diameters 2", 3", 4", 5", 6", 8".
- Coil length 50, 100 meters.
- Welded outlet, 1/2" BSPT colored green.
- Red colored strip for easy identification.
- Raw material, PP (Polypropylene). High UV resistance. Resistant to chemicals used in heap leaching mines.
- Maximum operating pressure according to pipes diameter.

→ **Technical data**

FlexNet™ HP	Inside diameter (mm)	Wall thickness (mm)	Outside diameter (mm)	Max. working pressure (bar)
2" / 51 mm	51.5	1.1	53.7	4.0
3" / 78 mm	78.3	1.1	80.5	4.0
4" / 102 mm	102.5	1.1	104.7	4.0
5" / 129 mm	129.0	1.1	131.2	3.0
6" / 163 mm	163.0	1.1	165.2	2.8
8" / 209 mm	209.0	1.1	210.7	2.0

→ **Packaging data**

FlexNet™ HP	Coil length (m)	Dimensions width x diameter (cm x cm)	Coil weight* blank / with connectors (kg)	Coils per pallet (units)	Coil length (m)	Dimensions width x diameter (cm x cm)	Coil weight* blank/with connectors (kg)	Coils per pallet (units)
2" / 51 mm	100	9.0*70	15 / 16	22	50	9.0*55	8 / 9	36
3" / 78 mm	100	14.0*70	27 / 28	14	50	14.0*55	13 / 14	28
4" / 102 mm	100	18.5*70	35 / 36	12	50	18.5*55	17 / 18	24
5" / 102 mm	100	22.0*70	38 / 39	10	50	22.0*55	17 / 18	10
6" / 163 mm	100	27.5*70	52 / 53	6	50	27.5*55	26 / 27	12
8" / 209 mm	100	33.5*70	62 / 63	6	50	33.5*55	31 / 32	12

* Calculated weight average. For further details see "Average Coil Weight Disclaimer".

→ **FlexNet HP™ pipes with integral welded connectors (1/2" FTH) - Catalog numbers**

FlexNet™ HP	0.50 m Between connections		1.00 m Between connections		1.20 m Between connections	
	50 meter	100 meter	50 meter	100 meter	50 meter	100 meter
2" / 51 mm	43000-006100	43000-006200	43000-006760	43000-006800		
3" / 78 mm	43000-009460	43000-009470	43000-008504	43000-010015		43000-010030
4" / 102 mm	43000-011850	43000-013870				43000-014035
5" / 129 mm						
6" / 163 mm						
8" / 209 mm			43000-015100	43000-015102		

* Missing catalog numbers available upon request

→	1.50 m Between connections		1.80 m Between connections		1.93 m Between connections	
	50 meter	100 meter	50 meter	100 meter	50 meter	100 meter
2" / 51 mm			43000-006940			
3" / 78 mm		43000-010050	43000-008600	43000-010100		
4" / 102 mm	43000-012050	43000-014050	43000-012100	43000-014100	43000-012200	
5" / 129 mm	43000-000027	43000-000028				
6" / 163 mm		43000-015003				
8" / 209 mm						

* Missing catalog numbers available upon request

→ **Blank pipes catalog numbers**

→	5.00 m Between conns.	8.00 m Between connections		10.00 m Between connections		FlexNet™ HP	Blank pipe 50 meter	Blank pipe 100 meter
	100 meter	50 meter	100 meter	50 meter	100 meter			
2" / 51 mm	43000-007240		43000-007275	43000-007320	43000-007360	2" / 51 mm	43000-000510	43000-000530
3" / 78 mm		43000-008780	43000-010280	43000-008800	43000-010300	3" / 78 mm	43000-000550	43000-000560
4" / 102 mm		43000-012270	43000-014270		43000-014300	4" / 102 mm	43000-000580	43000-000600
5" / 129 mm						5" / 129 mm	43000-000025	43000-000026
6" / 163 mm						6" / 163 mm	43000-000650	43000-000670
8" / 209 mm						8" / 209 mm	43000-000675	43000-000680

* Missing catalog numbers available upon request

** Other distances and configurations between integral welded connectors available upon request

Additional catalog numbers can be configured by the FlexNet™ on-line configurator: <http://productconfig.netafim.com/>

Connectors



Dripline Connectors

Netafim™ comprehensive range of driplines connectors are made of high chemical resistance and durability polymers. They are functional, modeled under the highest market standards and available for all driplines types.



High durability



Easy to install



User friendly

/ Benefits & Features

- **Exceptionally durable** Crafted from extremely durable and chemically resistant polymers.
- **Easy to install** Universally compatible with all driplines types and designed for ease of use.
- **High quality** Adhere to the highest industry standards, preventing leakage.

→ Technical Data

Connectors for HWD	Dripline	
	Internal diameter (mm)	Wall thickness (mm)
Barb for mining (Purple)		
16	14.2	0.9 - 1.2
20	17.5	1.0 - 1.2
Twist lock (black nut)		
16	14.2	0.9 - 1.2
20	17.5	1.0 - 1.2

→ Barb connectors for mining (purple)

Maximum working pressure: 3 bar

Barb coupling		16 mm	20 mm
	1 Unit	32500-010680	32500-007700
	50 Units/bag	32500-010685	32500-007721
	100 Units/bag	32500-010690	32500-007730

→ Start connectors

Seal for start barb connector model P

	1 Unit	32500-010450
	50 Units/bag	32500-010455
	100 Units/bag	32500-010460

Start connector barb 16 mm w/o seal, model P

	1 Unit	32500-014120
	50 Units/bag	-
	100 Units/bag	-

Seal EPDM f/16 mm start connector f/mines

	1 Unit	32500-013850
	50 Units/bag	-
	100 Units/bag	-

Compatible with 32500-010680
Recommended hole for barb start connectors - 19mm
45000-002760 in PE pipe up to 10 mm wall thickness

* Missing catalog numbers available upon request

* Missing catalog numbers available upon request

→ Twist lock (TL) HWD connectors

TL HWD Coupling	Size (mm)	Thread	Catalog number 1 Unit	Catalog number 50 Units/bag
	16	N/R	32530-000010	32530-000011
	20		32530-000030	32530-000031

TL HWD to Barb LDPE Coupling	Size (mm)	Thread	Catalog number 1 Unit	Catalog number 50 Units/bag
	16-16	N/R	32530-000410	32530-000411
	20-16		32530-000420	32530-000421
	16-20		32530-000430	32530-000431
	20-20		32530-000440	32530-000441

TL HWD End Line Plug	Size (mm)	Thread	Catalog number 1 Unit	Catalog number 50 Units/bag
	16	N/R	32530-000450	32530-000451
	20		32530-000460	32530-000461

TL HWD Straight MTH	Size (mm)	Thread	Catalog number 1 Unit	Catalog number 50 Units/bag
	16	½" MTH	32530-000060	32530-000061
		¾" MTH	32530-000070	32530-000071
	20	½" MTH	32530-000080	32530-000081
		¾" MTH	32530-000090	32530-000091

TL HWD Elbow MTH	Size (mm)	Thread	Catalog number 1 Unit	Catalog number 50 Units/bag
	16	½" MTH	32530-000150	32530-000151
		¾" MTH	32530-000160	32530-000161
	20	½" MTH	32530-000170	32530-000171
		¾" MTH	32530-000180	32530-000181



TL HWD Tee MTH	Size (mm)	Thread	Catalog number 1 Unit	Catalog number 50 Units/bag
	16	½" MTH	32530-000250	32530-000251
		¾" MTH	32530-000260	32530-000261
	20	½" MTH	32530-000270	32530-000271
		¾" MTH	32530-000280	32530-000281

→ FlexNet™ HP connectors kits

Note: All the products are supplied as a kit including the seal and metal band

Product picture	Product description	Catalog number
Coupling connector		
	FXN coupling 2" x 2" kit	43040-018000
	FXN coupling 3" x 3" kit	43040-018150
	FXN coupling 4" x 4" kit	43040-018300
	FXN HP coupling 6" x 6" kit 4 clamp	43040-100600
	FXN HP coupling 8" x 8" kit 4 clamp	43040-100700
Coupling connector with ready made port*		
	FXN coupling 2"+½" FTH BSP kit	43040-030600
	FXN coupling 3"+½" FTH BSP kit	43040-030700
	FXN coupling 4"+½" FTH BSP kit	43040-030800
Line end cap conector		
	FXN line end cap 2" kit	43040-020710
	FXN line end cap 3" kit	43040-020720
	FXN line end cap 4" kit	43040-020730
Barb x MTH BSP adaptor		
	FXN MTH 2" BSP x 2" kit	43040-018050
	FXN MTH 3" BSP x 3" kit	43040-018200
	FXN MTH 4" BSP x 4" kit	43040-018350
Barb x MTH NPT adaptor		
	FXN MTH 2" NPT x 2" kit	43040-018205
	FXN MTH 3" NPT x 3" kit	43040-018210
	FXN MTH 4" NPT x 4" kit	43040-018380
	FXN/FXN HP BARB 4" ANSI NPT 4"MIN. KIT (with SS316 clamps and Viton "O"-rings)	43040-018390
Barb x MTH BSP adaptor with ready made port		
	FXN MTH 2" BSP x 2"+½" FTH BSP kit	43040-030900
	FXN MTH 3" BSP x 3"+½" FTH BSP kit	43040-031000
	FXN MTH 4" BSP x 4"+½" FTH BSP kit	43040-031100

*½" threaded outlet

Product picture	Product description	Catalog number
Barb x PVC SW adaptor		
	FXN SW adapter ISO 50/63 x 2" kit	43040-018100
	FXN SW adapter ISO 75/90 x 3" kit	43040-018250
	FXN SW adapter ISO 110" x 4" kit	43040-018400
	FXN SW adapter ASTM 1½/2" x 2" kit	43040-018605
	FXN SW adapter ASTM 2½/3" x 3" kit	43040-018610
	FXN SW adapter ASTM 4" x 4" kit	43040-018381
	FXN/FXN HP BARB 4" SW ISO 110 MIN. KIT (with SS316 clamps and Viton "O"-rings)	43040-018420
	FXN HP SW ISO 160mm x 6" kit 2 clamp	43040-100601
	FXN HP SW ISO 200mm x 8" kit 2 clamp	43040-100701
	FXN HP SW ASTM 6" x 6" kit 2 clamp	43040-100602
	FXN HP SW ASTM 8" x 8" kit 2 clamp	43040-100702

Barb X PVC SW ISO adaptor with ready made port

	FXN SW adapter ISO 50/63 x 2"+½" FTH kit	43040-031200
	FXN MTH 3" BSP x 3"+½" FTH BSP kit	43040-031300
	FXN SW adapter ISO 110" x 4"+½" FTH kit	43040-031400

Elbow connector

	FXN elbow 2" x 2" kit	43040-018900
	FXN elbow 3" x 3" kit	43040-019000
	FXN elbow 4" x 4" kit	43040-019100



"T" connector

	FXN tee 2" x 2" x 2" kit	43040-019500
	FXN tee 3" x 3" x 3" kit	43040-019600
	FXN tee 4" x 4" x 4" kit	43040-019700
	FXN tee 6" x 6" x 6" kit	43040-000420



"T" transition connector

	FXN tee 3" x 2" x 3" kit	43040-020100
	FXN tee 4" x 3" x 4" kit	43040-020200



* Two clamps on each side are needed due to the FlexNet HP™ nominal pressure

Product picture	Product description	Catalog number
Transition connector		
	FXN reducing adapter 3" x 2" kit	43040-020300
	FXN reducing adapter 4" x 3" kit	43040-020400
Flange-Barb		
	FXN flange ISO 63 x 2" kit	43040-030000
	FXN flange ISO 90 x 3" kit	43040-030100
	FXN flange ISO 110 x 4" kit	43040-030200
Flushing line end		
	FXN flush valve x 2" kit	43040-030300
	FXN flush valve x 3" kit	43040-030400
	FXN flush valve x 4" kit	43040-030500
	FXN flush valve x 6" kit	43040-030501
	FXN flush valve x 8" kit	43040-030502

→ FlexNet™ HP connector threading tools

Product picture	Product description	Catalog number
	1/2" BSP hand tap (thread)	45000-003185
	Flat wood drill bit 18 mm for BSP 1/2" tap	45000-003162



→ FlexNet™ HP complementary products

Product picture	Product description	Catalog number
	FXN plug 1/2" MTH + O ring/50 bag	42000-027105
	FXN plug 1/2" MTH + O ring/100 bag	42000-027110
	NetaFix NFP puncture fix kit box	42000-007000
	NetaFix NFP spare parts /20 bag	42000-007010

→ FlexNet™ HP spare parts

Product picture	Product description	Catalog number
	FXN SS304 clamp 2"	43040-100000
	FXN SS304 clamp 3"	43040-100010
	FXN SS304 clamp 4"	43040-100020
	FXN SS304 clamp 6"	43040-100030
	FXN CLAMP 2" SS316 , high durability in mine environment	43040-000200
	FXN CLAMP 3" SS316 , high durability in mine environment	43040-000210
	FXN CLAMP 4" SS316 , high durability in mine environment	43040-000220
	FXN oring seal EPDM 40*4.538 for 2"	43040-006200
	FXN oring seal EPDM 60x4.5 for 3"	43040-006230
	FXN oring seal EPDM 80x4.5 for 4"	43040-006260
	FXN rubber seal f/barb conn. 6"	43020-010000

→ FlexNet™ HP laying and retrieving machine

Product picture	Product description	Catalog number
Hydraulic machine		
	Laying and recoiling machine for FlexNet™ 2"-4"	77200-001130
Electrical machine		
	Electrical retrieval machine for FlexNet™ 2"-4"	77200-000065

Product picture	Product description	Catalog number
Manual machine		
	Manual retrieval machine for FlexNet™ 2"-4"	77200-001131

Pressure Regulator



In-Line PRV

Pressure regulator, specially designed for mining applications to deliver uniform pressure even in long lines.

Chemical-resistant pressure regulator offers easy installation, both for driplines and sprinklers.



Very high efficiency



Superb quality



High durability

/ Benefits & Features

- **High performance** Continuous non-peak, consistent pressure and maximum system uptime - for efficient leaching.
- **Extremely reliable** Provides constant pressure to the laterals regardless of upstream pressure rises.
- **Exceptionally durable** Made from acid and cyanide-resistant materials.

/ Specifications

- Available in 5 optional output pressures: 1.1 bar/15 psi, 1.4 bar / 20 psi, 1.8 bar / 26 psi, 2.5 bar / 35 psi, 3 bar / 43 psi .
- Maximum inlet pressure 4 bar / 60 psi.
- Flow rate range 100-1000 l/h.
- Connections MTH 3/4" - MTH 3/4".
- Raw material PBT.
- Device length 7 cm.

→ **Head loss**

Pressure (bar) vs flow rate (l/h)

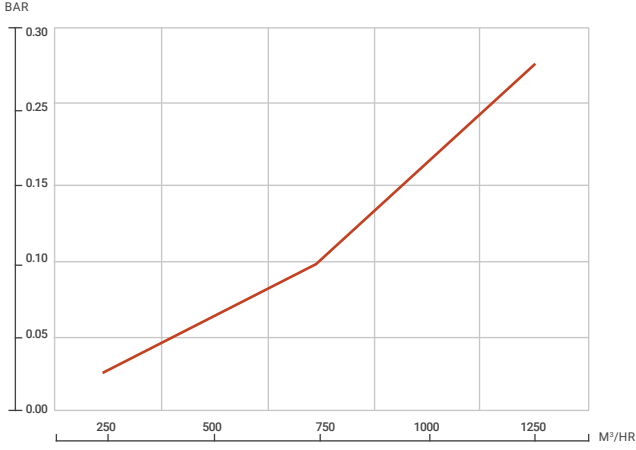

→ **Outlet pressure**

Pressure (bar) vs flow rate (l/h)

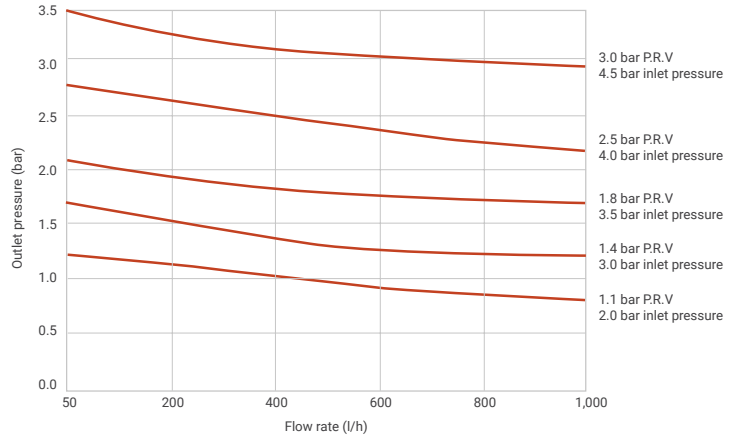

→ **Catalog numbers**

Description	Flow range (m³/h - gpm)	Nominal output pressure (bar - psi)	Max operating pressure (bar - psi)	Catalog number
Inline P.R.V 3/4" 1.1 bar 15 psi mining	0.05-1 / 0.25-4.4	1.1 / 15	4 / 60	31000-001100
Inline P.R.V 3/4" 1.1 Bar 15 psi min Viton		1.1 / 15		31000-001115
Inline P.R.V 3/4" 1.4 Bar 20 psi mining		1.4 / 20		31000-001140
Inline P.R.V 3/4" 1.8 Bar 25 psi mining		1.8 / 25		31000-001180
Inline P.R.V 3/4" 2.5 Bar 35 psi mining		2.5 / 35		31000-001300
Inline P.R.V 3/4" x 1/2" 1.1 bar mining		1.1 / 15		31000-002300
Inline P.R.V 3/4" x 1/2" 1.4 bar mining		1.4 / 20		31000-002330
Inline P.R.V 3/4" x 1/2" 1.8 bar mining		1.8 / 25		31000-002360
Inline P.R.V 3/4" x 1/2" 2.5 bar mining	2.5 / 35	31000-002390		

Valves



75 Series

The strong and versatile polypropylene valves of 75 series, exhibit exceptional hydraulic characteristics and provide optimal control of leaching systems.



Superb
quality



High
durability



Extremely
versatile

/ Benefits & Features

- **Outstanding performance** This industry standard series has extremely high flow capacity due to its flexible mechanism that provides a wide water passage.
- **Super Robust** Component materials are resistant to strong acids used in the leaching process.
- **Ultimate Reliability** Long life and easy inline maintenance accomplished by structural simplicity.
- **Great versatile** Available with full selection of control functions and various end connections.

/ Specifications

- Maximum pressure - 8 bar (115 psi).
- Minimum recommended flow - 1 m³/h (5 gpm).
- Maximum operating temperature - 60°C (140°F).

→ Hydraulic performance

Diameter	inch	¾	1	1½	2	2½	3R*	3	4R*	3H**	4	6R*
	mm	20	25	40	50	65	80	80	100	80	100	150
Flow rate factor***	Kv	7.5	15	60	70	75	80		120	250		350
	Cv	9	17.5	70	80	90	95		140	290		410

* R - "Reduced" - 3R = 323", 4R = 434", 6R = 646"

** H - "High Flow" - 3H = 434

*** In order to calculate the head loss at any desired flow rate, use the following equation: Head loss = (Flow rate/Flow rate factor)²

→ Technical dimensions

Diameter	inch	¾	1	1½	2	2½	3R*	3*	4R*	4	6R*
	mm	20	25	40	50	65	80	80	100	100	150
Height	H	60.5/2.42		122.6/4.90	117.6/4.70	118.7/4.75	124.9/5.00	174/6.90	227/9.10	229/9.00	284/11.18
Width	W	89.5/3.58		130.8/5.23				170/6.80		236/9.29	285/11.22
Length	L	113/4.50	124/4.87	188/7.37	199/7.87	228/9.00	236/9.25	258/10.30	291.5/11.66	370/14.56	420/16.53
Vol. control chamber	cc / gal	36/0.01			180/0.04			250/0.05		400/0.11	
Weight	kg / lbs	0.2/0.44		0.9/2		1.2/2.6	1.4/3.1	3.1/6.8	2/4.4	5.95/13.1	7.95/17.5

Threaded

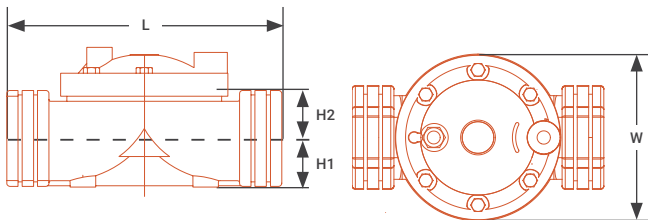

Grooved

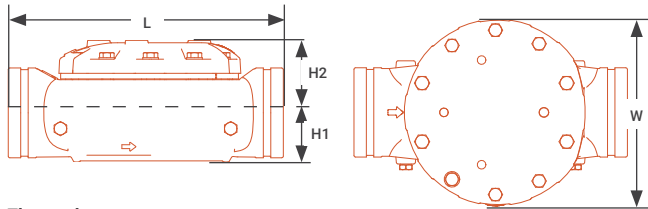

Flanged

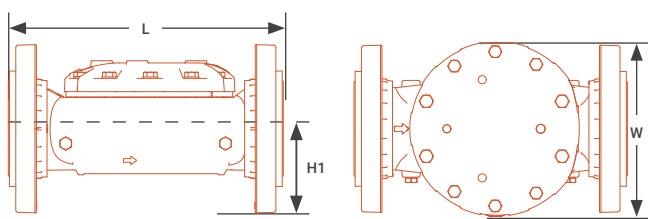

→ Components raw materials

#	Part Name	Material
1	Body	Polypropylene
2	Bonnet	Polypropylene
3	Diaphragm	ALD70
4	Spring	SST 316

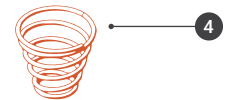
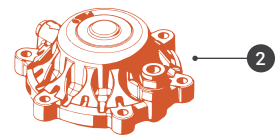

→ Head loss

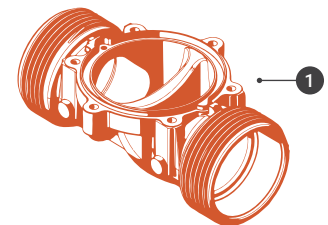
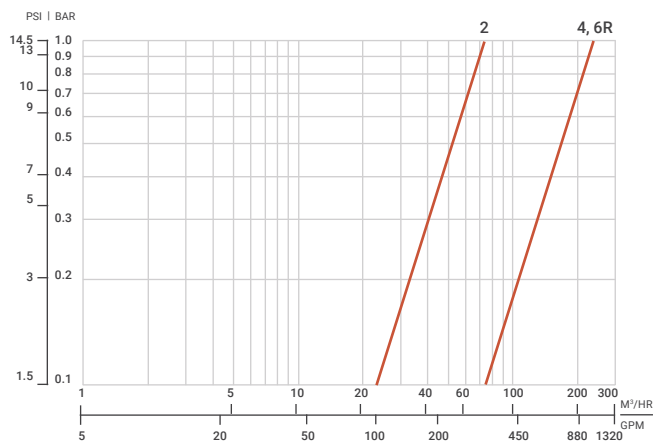

→ Description guide

To correctly define a valve with its respective accessories and according to the needs, the following selection parameters can be used.

→ Flowchart to determine the desired product definition

1 Serie		2 Material		3 Nominal diameter		4 Configuration		5 Connection		6 Main function	
S75	PP	Polypropylene	¾"	¾" (20 mm)	H	Horizontal	NPT	NPT	BAS	Basic	
			1"	1" (25 mm)	A	Angle	BSP	BSP	MAN	Manual control on/off	
			1½"	1½" (40 mm)			UNF	Universal flange*	HYD	Hydraulic control on/off	
			2"	2" (50 mm)			VIC	Grooved	ELE	Electric control on/off	
			2½"	2½" (65 mm)			GLUE	PVC solvent welded	PRV	Pressure reducing	
			3"R	323" (80 x 50 x 80 mm)					PSV	Pressure sustaining (& relief)	
			3"	3" (80 mm)					PRS	Pressure reducing & sustaining	
			3"H	343" (80 x 100 x 80 mm)					FLV	Flow control	
			4"R	434" (100 x 80 x 100 mm)					QRV	Quick relief	
			4"	4" (100 mm)					LCV	Level control	
			6"R	6" (150 x 100 x 150 mm)					SAV	Surge anticipating	
									TOV	Pressure reducing, two stage opening	
						TSV	Pressure reducing, two sets of pressure				
						PCV	Pump control valve				

7 Pilot		8 Pilot spring		9 Solenoid type		10 Valve's mode		11 Accessories	
PP	Plastic pilot	Y	Yellow spring	AQAC	Solenoid Aqautive 24AC	3WNC	3-Way N.C	C/2C	Check point (1 unit, 2 unit)
MP	Metal pilot*	G	Green spring	AQDC	Solenoid Aqautive 12-40VDC latch	2WNC	2-Way N.C	P/2P	Pressure gauge (1 unit, 2 unit)
		R	Red spring	D24A	Dorot solenoid 24VAC	3WNO	3-Way N.O	H	Hydraulic relay
				D24D	Dorot solenoid 24VDC	2WNO	2-Way N.O	F	Float
				D12D	Dorot solenoid 12VDC	2W	2-Way*	O	Orifice
				D12L	Dorot solenoid 12VDC latch	3W	3-Way*	T	Shuttle T
				24AC	Other solenoid 24VAC	* Manual control only			
				24DC	Other solenoid 24VDC			N	Non-return feature
				12DC	Other solenoid 12VDC			S	3 Way manual valve
				12DL	Other solenoid 12VDC latch			LP	Low pressure diaphragm
								HP	High pressure diaphragm
								MIN	Mining
								SV	Shreader

→ Catalog numbers examples

Serie	Material	Diameter (inch)	Configuration	Connection type	Main function	Solenoid type/Pilot	Valves mode	Accessories	Catalog number
S75	PP	1"	H	NPT	ELE	24AC	3WNC	S MIN	71640-000754
S75	PP	2"	H	BSP	BAS		3W	N MIN	71600-000035
S75	PP	2"	H	BSP	PRV	PPY	3W	C MIN	71600-000163
S75	PP	2"	H	BSP	PRV	PPY	3W	C S MIN	71600-002327
S75	PP	2"	H	BSP	PRV	PPY	3W	C S MIN	71600-008798
S75	PP	3"	H	BSP	ELE	AQDC	3WNC	MIN	71640-000076
S75	PP	3"H	H	NPT	PRV	PPG	3W	C MIN	71600-000133
S75	PP	3"H	H	BSP	PRV	PPG	3W	C MIN	71600-000136
S75	PP	3"H	H	NPT	ELE	AQDC	3WNC	MIN	71640-000075
S75	PP	4"	H	UNF	PRV	PPG	3W	C MIN	71600-000134
S75	PP	4"	H	UNF	ELE	AQDC	3WNC	MIN	71640-000074
S75	PP	6"R	H	UNF	PRV	PPG	3W	C MIN	71600-000135
S75	PP	6"R	H	UNF	ELE	AQDC	3WNC	MIN	71640-000073

*Other configurations are available upon request

The products defined for mining (MIN) are composed of ALD* diaphragms and SST 316 (stainless steel) spring.

*ALD The qualities and resistance of this material are presented below.

Some of these valves can also be ordered with the relevant components manufactured of Hastelloy (resistant against chlorine gas, hypochlorite and chlorine dioxide solutions). The alloy is characterized by excellent resistance against concentrated solutions of oxidizing salts (such as iron III and copper chloride)

90 Series

Solvent-welded and threaded valves from the 90 series are crafted from PVC, providing reliable control for leaching systems.



High durability



Very high efficiency



Extremely versatile

/ Benefits & Features

- **High durability** An exclusive valves series that is highly resistant through the use of high-quality, corrosion-free PVC. Could be directly glued/threaded to any pipe.
- **Superior performance** Excellent regulation capabilities achieved by a flexible diaphragm mechanism that is designed to allow maximal to near zero flow while operation.
- **Extremely versatile** Full selection of control functions and end connections available. Optional sub surface installation reduces costs and friction losses by eliminating use of elbow joints.

/ Specifications

- Maximum pressure
3" (90 mm) & 4" (110 mm) - 8 bar / 115 psi.
6" (160 mm) - 10 bar / 145 psi.
- Minimum recommended flow - 1 m³/h (5 gpm).
- Minimum operating pressure - 0.6 bar (8 psi).
- Maximum operating temperature - 40°C (104°F).

→ **Technical dimensions**

Diameter		inch	3	4	6
		mm	90	110	160
Height	H1		208 / 8.06	208 / 8.06	382 / 15
Width	W	mm / inch	229/9.16	229/9.16	260/10.40
Length	L		258/10.18	258/10.18	360/14.18
Volume control chamber	cc / gal		0.7/0.18		2.6/0.68
Weight	kg / lbs		4.0/8.8	4.2/9.2	11.8/26

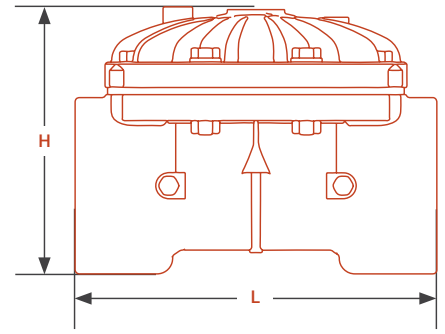

Diameter		inch	3	4	6
		mm	90	110	160
Flow rate factor*	Kv (metric)		155	215	480
	Cv (US)		180	250	560
Pressure range	WMC		6-80		5-100
	PSI		9-115		7-150

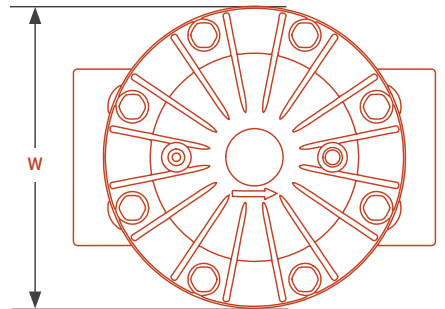

* In order to calculate the head loss at any desired flow rate, use the following equation:
 Head loss = (Flow rate/Flow rate factor)²

→ **Head loss**

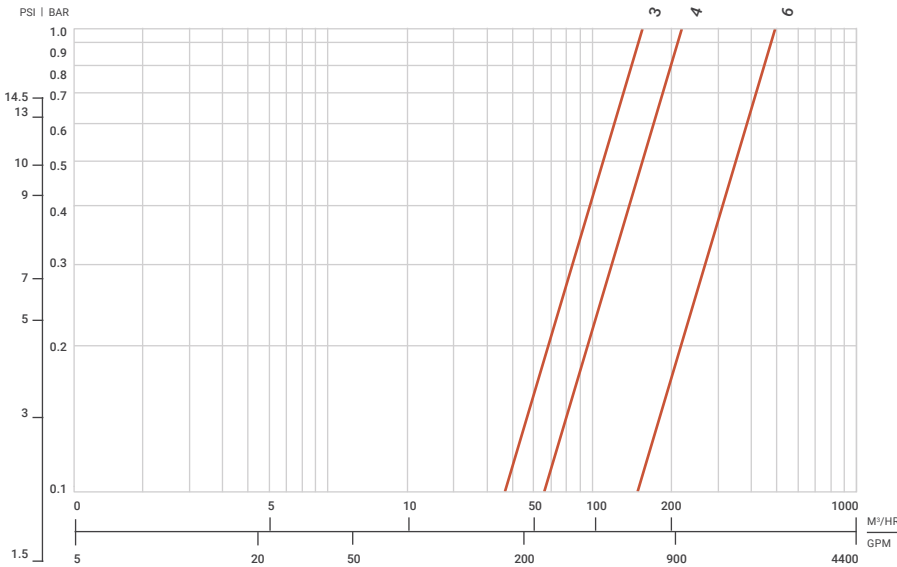

→ **Components raw materials**

#	Part name	Material
1	Body	PVC
2	Bonnet	PPS
3	Diaphragm	ALD70
4	Spring	SST 316

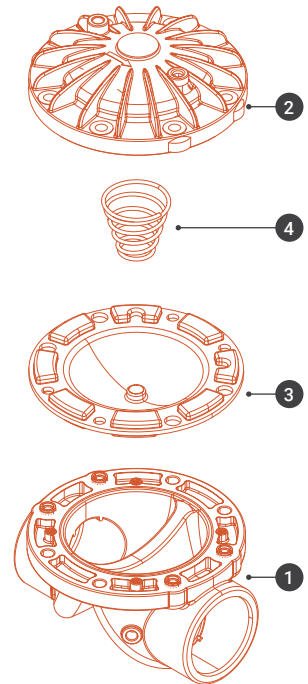

→ Description guide

To correctly define a valve with its respective accessories and according to the needs, the following selection parameters can be used.

→ Flowchart to determine the desired product definition

1 Serie		2 Material		3 Nominal diameter		4 Configuration		5 Connection		6 Main function	
S90	PV	PVC	3"	3" (80 mm)	H	Horizontal	NPT	NPT	BAS	Basic	
			4"	4" (100 mm)	A	Angle	BSP	BSP	MAN	Manual control on/off	
			6"	6" (150 mm)			UNF	Universal flange*	HYD	Hydraulic control on/off	
						VIC	Grooved	ELE	Electric control on/off		
						GLUE	PVC solvent welded	PRV	Pressure reducing		
								PSV	Pressure sustaining (& relief)		
								PRS	Pressure reducing & sustaining		
								FLV	Flow control		
								QRV	Quick relief		
								LCV	Level control		
								SAV	Surge anticipating		
								TOV	Pressure reducing, two stage opening		
								TSV	Pressure reducing, two sets of pressure		
								PCV	Pump control valve		

7 Pilot		8 Pilot spring		9 Solenoid type		10 Valve's mode		11 Accessories	
PP	Plastic pilot	Y	Yellow spring	AQAC	Solenoid Aqautive 24AC	3WNC	3-Way N.C	C/2C	Check point (1 unit, 2 unit)
MP	Metal pilot*	G	Green spring	AQDC	Solenoid Aqautive 12-40VDC latch	2WNC	2-Way N.C	P/2P	Pressure gauge (1 unit, 2 unit)
		R	Red spring	D24A	Dorot solenoid 24VAC	3WNO	3-Way N.O	H	Hydraulic relay
				D24D	Dorot solenoid 24VDC	2WNO	2-Way N.O	F	Float
				D12D	Dorot solenoid 12VDC	2W	2-Way*	O	Orifice
				D12L	Dorot solenoid 12VDC latch	3W	3-Way*	T	Shuttle T
				24AC	Other solenoid 24VAC			N	Non-return feature
				24DC	Other solenoid 24VDC			S	3 Way manual valve
				12DC	Other solenoid 12VDC			LP	Low pressure diaphragm
				12DL	Other solenoid 12VDC latch			HP	High pressure diaphragm
								MIN	Mining
								SV	Shreader

→ Catalog numbers examples

Serie	Material	Diameter (mm)	Configuration	Connection type	Main function	Solenoid type/Pilot	Valves mode	Accessories	Catalog number
S90	PV	2"	H	Glue	PRV	PPG	3WNC	C MIN	71600-005833

*Other configurations are available upon request

The products defined for mining (MIN) are composed of ALD* diaphragms and SST 316 (stainless steel) spring.

*ALD The qualities and resistance of this material are presented below.

Some of these valves can also be ordered with the relevant components manufactured of Hastelloy (resistant against chlorine gas, hypochlorite and chlorine dioxide solutions). The alloy is characterized by excellent resistance against concentrated solutions of oxidizing salts (such as iron III and copper chloride)

Flushing valve with timer

Flushing cycles within a defined time frame. The combination of two products allows us to offer this specific application as an automatic flushing valve, the timer gives the pipe flushing orders automatically according to its programming.



Labor saving



Very high efficiency



Resistant

/ Benefits & Features

- **Labor saving** Automatic washing times can be set
- **Very high efficiency** Works with a 9V battery
- **Resistant** High resistance to extreme environmental conditions

/ Specifications

- Raw material: PP (75 Series) or PVC (90 Series).
- Connections: threaded / flanged / PVC glued.
- Timer specifications:
 - Operating temperature -10° to 60°C.
 - Powered by a single 9V alkaline battery (use best quality to ensure at least one year's autonomous operation).
 - Back-up memory.
 - Low battery warning.
 - Power saving LCD.
 - Battery included.
 - CED Standard certification.
 - Standard protection class; dust and watertight, IP67 and NEMA 4X.
- Programming key features:
 - Set start and end hours.
 - Set On time (1 second to 12 hours).
 - Set Off time (1 min to 12 hours).
 - Day selects.
 - Off.

→ Catalog numbers examples

Serie	Material	Diameter (inch)	Configuration	Connection type	Main function	Solenoid type/Pilot	Valves mode	Accessories	Catalog number
S75	PP	2"	H	BSP	ELE	AQDC	3WNC	Timer	71640-003435



100 Series

The powerful and reliable metal valves of 100 series displays remarkable hydraulic performance, providing ultra-precise control of leaching and other mining systems.



Stainless Steel



Ductile Iron



High durability



Very high efficiency



Extremely versatile

/ Benefits & Features

- **Extremely Robust** This durable valves series, characterized by structural simplicity and the use of materials that can withstand the harshest conditions.
- **Outstanding performance** High flow capacity and very low head losses achieved by a flexible diaphragm, providing a wide water passage throughout the valve's hydrodynamic body.
- **Highly versatile** The valves are available in globe and angle shapes, with a wide range of materials, control functions, and end connections available.

/ Specifications

- Maximum pressure - 16 bar (230psi) and 25 bar (365 psi).
- Minimum recommended flow - 1 m³/h (5 gpm).
- Minimum operating pressure - 0.4 bar (6 psi).

→ **Technical dimensions**

Straight flow, flanged connection - standard models 16 Bar / 250 psi

Valve size		L		H		D		W		Weight	
mm	inch	mm	inch	mm	inch	mm	inch	mm	inch	kg	lbs
50	2	200	7.87	166	6.54	85	3.35	166	6.54	8	18
65	2.5	214	8.43	185	7.28	92.5	3.64	185	7.28	12	25
80	3	285	11.22	200	7.87	105	4.13	200	7.87	19	42
100	4	395	15.55	230	9.06	110	4.33	230	9.06	25	54
150	6	490	19.29	314	12.36	145	5.71	300	11.8	51	113
200	8	560	22.05	400	15.75	170	6.69	365	14.4	89	197
250	10	635	25.00	445	17.52	205	8.07	440	17.3	131	288
300	12	710	27.95	495	19.49	240	9.45	490	19.3	174	384
350	14	785	30.90	495	19.49	270	10.6	530	20.9	203	448

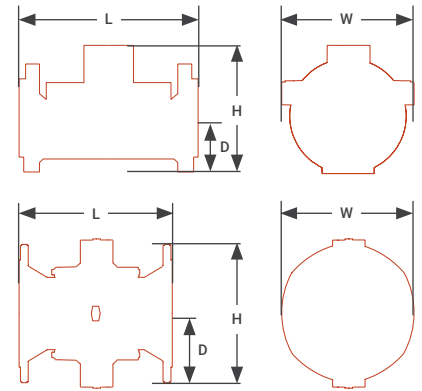

→ **Hydraulic performance**

Shape	Straight											Angle		
	inch	2	2½	3	4	6	8	10	12	14	3	4	6	
Diameter	mm	50	65	80	100	150	200	250	300	350	80	100	150	
	Flow rate factor**	Kv	95	95	170	220	600	800	1250	1900	1900	150	200	570
		Cv	110	110	200	255	695	925	1445	2195	2195	175	230	660

* In order to calculate the head loss at any desired flow rate, use the following equation:
 Head loss = (Flow rate/Flow rate factor)²

→ **Head Loss**

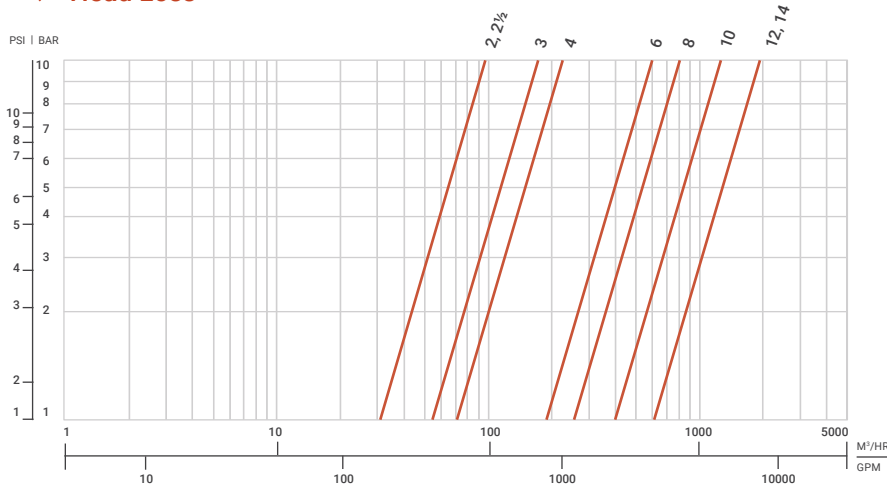

→ **Components raw materials**

#	Part name	Material	Optional
1	Body	SST 316	Ductile iron
2	Bonnet	SST 316	Ductile iron
3	Diaphragm	ALD70	Natural rubber
4	Spring	SST 316	SST 302

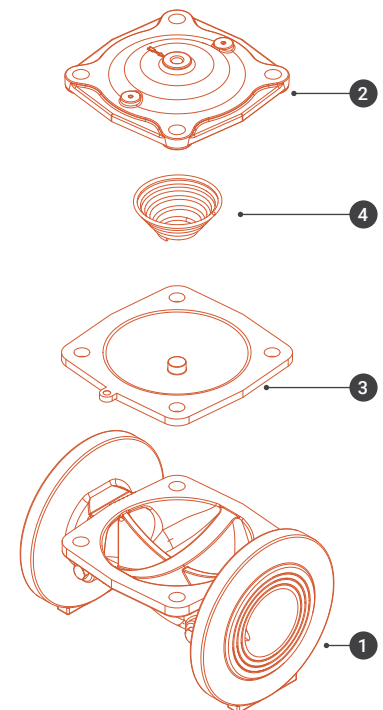

→ Description guide

To correctly define a valve with its respective accessories and according to the needs, the following selection parameters can be used.

→ Flowchart to determine the desired product definition

1 Serie	2 Material		3 Nominal diameter		4 Configuration		5 Conection		6 Main function	
S100	CI	Cast iron	2"	2" (50 mm)	H	Horizontal	DN10	ISO PN10	BAS	Basic
	DI	Ductile iron	2½"	2½" (65 mm)	A	Angle	DN16	ISO PN16	MAN	Manual control on/off
	BR	Bronze	3"	3" (80 mm)	*Angle model only in 3", 4" and 6"		AN12	ANSI 125	HYD	Hydraulic control on/off
	ST	Stainless steel	4"	4" (100 mm)			AN15	ANSI 150	ELE	Electric control on/off
			6"	6" (150 mm)			BSTD	BSTD	PRV	Pressure reducing
			8"	8" (200 mm)	BSTE	BSTE	PSV	Pressure sustaining (& relief)		
			10"	10" (250 mm)	ABNT	ABNT	PRS	Pressure reducing & sustaining		
			12"	12" (300 mm)			FLV	Flow control		
			14"	14" (350 mm)			QRV	Quick relief		
							LCV	Level control		
						SAV	Surge anticipating			
						TOV	Pressure reducing, two stage opening			
						TSV	Pressure reducing, two sets of pressure			
						PCV	Pump control valve			

7 Pilot		8 Pilot spring		9 Solenoid type		10 Valve's mode		11 Accessories	
PP	Plastic pilot	Y	Yellow spring	AQAC	Solenoid Aqautive 24AC	3WNC	3-Way N.C	C/2C	Check point (1 unit, 2 unit)
MP	Metal pilot*	G	Green spring	AQDC	Solenoid Aqautive 12-40VDC latch	2WNC	2-Way N.C	P/2P	Pressure gauge (1 unit, 2 unit)
* for metal valve only		R	Red spring	D24A	Dorot solenoid 24VAC	3WNO	3-Way N.O	H	Hydraulic relay
		D24D	Dorot solenoid 24VDC	2WNO	2-Way N.O	F	Float		
				D12D	Dorot solenoid 12VDC	2W	2-Way*	O	Orifice
				D12L	Dorot solenoid 12VDC latch	3W	3-Way*	T	Shuttle T
				24AC	Other solenoid 24VAC	* Manual control only		N	Non-return feature
				24DC	Other solenoid 24VDC			S	3 Way manual valve
				12DC	Other solenoid 12VDC			LP	Low pressure diaphragm
				12DL	Other solenoid 12VDC latch			HP	High pressure diaphragm
						MIN	Mining		
						SV	Shreader		

ALD Diaphragm Resistance

	Chemical formula	Remarks
1	Sewage	
2	Sodium Bisulphite NaHSO ₃	60°C Max
3	Aluminum Sulphate Al ₂ (SO ₄) ₃	60°C Max
4	Ca-NH ₃	38°C Max
5	Salt Water NaCl/H ₂ O	70°C Max
6	Sea Water	70°C Max
7	Urea CO (NH ₂) ₂	60°C Max
8	Ammonium Nitrate Solvations NH ₄ NO ₃	70°C Max
9	Sodium Hypochlorite NaOCl	Limit to 80°C 100mg/liter
		Limit to 30°C 170mg/liter
10	Hydrochloric Acid HCl	Limit 10% 70°C
		Good 10% 25°C
		Good 20% 100°C
		Good 35% 25°C
		Not Good 35% 100°C
11	Sulphuric Acid H ₂ SO ₄	38°C Max
12	Phosphoric Acid H ₃ PO ₄	Limit 10% 60°C
		Limit 50% 22°C
		Not Good 85%
13	Copper Sulphate CuSO ₄	70°C Max
14	Potassium Permanganate KMnO ₄	10%, 25%, 35% Max
15	Caustic Soda NaOH	Limit 15%-50% 70°C
		Limit 70% 38°C
		According German research
		Good to 5% 50°C
		Good to 50% 100°C
		Good to 70% 50°C
Good to 70% 100°C		
16	Nitric Acid HNO ₃	Not Good 10%
17	Chlorine Dioxide ClO ₂	Not Good
18	Chlorine Gas Cl ₂	Not Good
19	Potassium Sulphate K ₂ SO ₄	60°C Max

* for other solution please contact your local Netafim™ representative.

True Union Ball Valve

For a simple open/close function, whenever manual control or maintenance is needed, in any solution conveyance system.



Very high efficiency



High durability



User friendly

/ Benefits & Features

- **Operationally efficient design** Quarter turn shut off valve, threaded or glued socket, user-friendly design allowing smooth handle operation. True union ball valve, specifically designed for water application and safe pipeline operation.
- **Extremely resistant** Made from corrosion-resistant, UV-stable materials. Highly reliable operation and durability over time.
- **Easy maintenance** In closed position, pipeline can be disconnected downstream from the valve without any leakage; valve is removable from pipeline for quick maintenance.

/ Specifications

- Temperature range of -5°C and 50°C, guaranteeing optimal performance in terms of mechanical resistance, good rigidity, low coefficients of thermal expansion and optimal safety factors in service.
- Operational up to 10 bar.
- Very low head losses.
- Wide range of connections - threaded (BSP or NPT standards) or SG, socket glued (ISO/DIN, ASTM, BS).

→ Packaging data

Model	Quantity p/box (units)	Box sizes (cm x cm x cm)	Female-female threaded connection box weight (kg)	Male-female threaded connection box weight (kg)	Socket glued connection box weight (kg)	Boxes p/pallet
½" - 20MM	150	43.0 x 33.0 x 39.0	24.55	26.00	24.70	12
¾" - 25MM	150		22.11	23.83	22.33	
1" - 32MM	75		17.03	17.74	16.84	
1¼" - 40MM	50		17.54	18.09	17.34	
1½" - 50MM	16		10.91	10.58	10.53	
2" - 63MM	8		8.68	8.90	8.52	
2½" - 75 MM	8		12.08	12.04	11.86	
3" - 90MM	4		15.93	13.09	12.85	
4" - 110MM	2		9.84	9.64	9.84	

→ Head loss

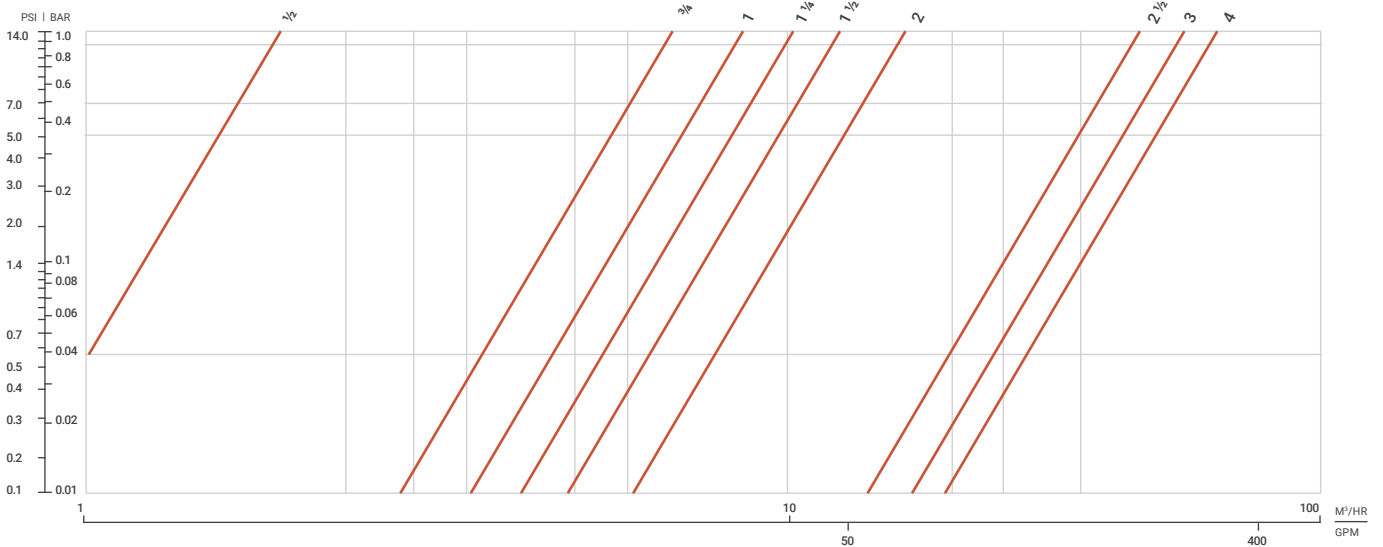

→ **Technical dimensions**

True union ball valves 1/2", 3/4", 1", 1 1/4" for mining

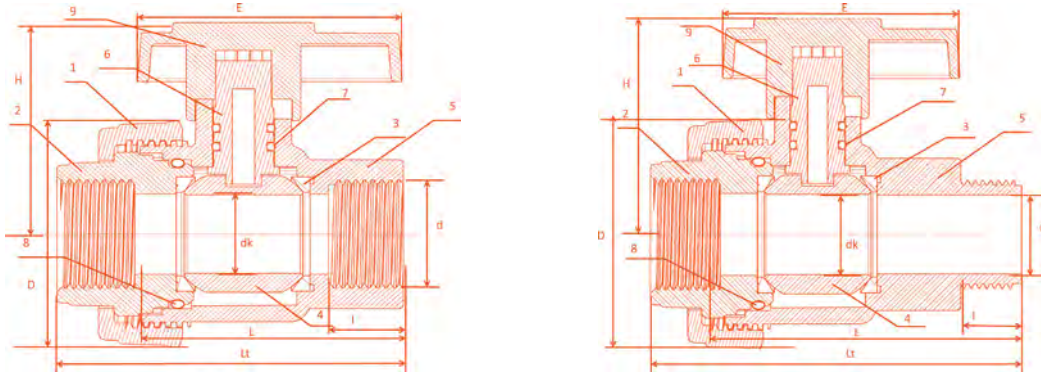

→ **Components raw materials**

PVC ball valves 1/2", 3/4", 1", 1 1/4" for mining

Inlet connector - threaded male / outlet connector - threaded female

size \ nom	BSP (TPI)	NPT (TPI)	DK (mm)	D (mm)	l (mm)	L (mm)	LT (mm)	E (mm)	H (mm)
1/2"	14.00	14.00	20.00	60.00	16.00	80.20	99.15	60.80	56.50
3/4"	14.00	14.00	20.00	60.00	18.00	80.20	99.15	60.80	56.50
1"	11.00	11.50	24.50	69.00	17.70	89.00	110.40	71.00	66.45
1 1/4"	11.00	11.50	31.80	79.50	25.70	88.00	122.80	105.00	70.30

#	Part name	Material	Qty.
1	Ring	UPVC	1
2	Bush**	UPVC	1
3	Seal	PTFE	2
4	Ball	UPVC	1
5	Body	UPVC	1
6	Shaft	UPVC	1
7	Shaft o-ring	VITON	2
8	Main o-ring**	VITON	1
9	Handle	PPFG	1
10	Threaded bush*	UPVC	1
11	Bush big o-ring*	VITON	1
12	Bush small o-ring*	VITON	1
13	Socket*	UPVC	1

* 1 1/4" Ball Valve

** 3/4" Ball Valve

Inlet connector - threaded female / outlet connector - threaded female

size \ nom	BSP (TPI)	NPT (TPI)	DK (mm)	D (mm)	l (mm)	L (mm)	LT (mm)	E (mm)	H (mm)
1/2"	14.00	14.00	20.00	60.00	16.00	63.50	82.60	60.80	56.50
3/4"	14.00	14.00	20.00	60.00	18.00	63.50	82.60	60.80	55.50
1"	11.00	11.50	24.50	69.00	19.55	70.50	93.00	71.00	66.45
1 1/4"	11.00	11.50	31.80	79.50	27.40	88.00	122.80	105.00	70.30

Inlet connector - socket glued / outlet connector - socket glued

size \ nom	BSP (TPI)	NPT (TPI)	DK (mm)	D (mm)	l (mm)	L (mm)	LT (mm)	E (mm)	H (mm)
20mm	20.20	20.20	20.00	60.00	16.00	63.50	82.60	60.80	56.60
25mm	25.00	25.00	20.00	60.00	18.00	63.50	82.60	60.80	55.60
32mm	32.00	32.00	24.50	69.00	19.55	70.50	93.00	71.00	66.45
40mm	40.00	40.00	31.80	79.50	27.40	88.00	122.80	105.00	70.30

Inlet connector - socket glued / outlet connector - socket glued

size \ nom	BSP (TPI)	NPT (TPI)	DK (mm)	D (mm)	l (mm)	L (mm)	LT (mm)	E (mm)	H (mm)
1/2"	21.20	21.40	20.00	60.00	18.00	63.50	82.60	60.80	55.60
3/4"	26.67	26.00	20.00	60.00	18.00	63.50	82.60	60.80	55.60
1"	33.40	34.00	24.50	69.00	19.55	70.50	93.00	71.00	66.45
1 1/4"	42.16	42.00	31.80	79.50	27.40	88.00	122.80	105.00	70.30

→ **Technical dimensions**

True union ball valves 1½", 2", 2½", 3" for mining

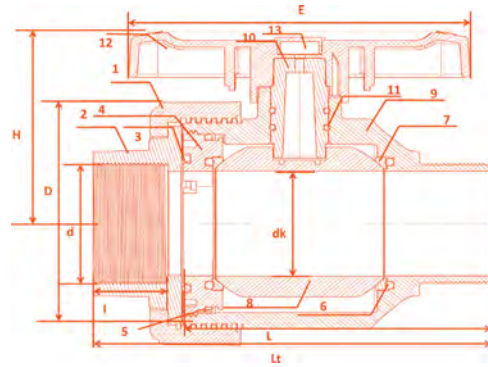
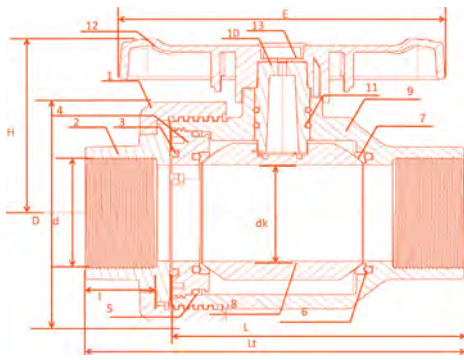

Inlet - threaded male / outlet connector - threaded female

size \ nom	BSP (TPI)	NPT (TPI)	DK (mm)	D (mm)	I (mm)	L (mm)	LT (mm)	E (mm)	H (mm)
1½"	11.00	11.50	39.40	94.40	32.00	98.50	136.60	121.00	90.80
2"	11.00	11.50	49.50	116.00	35.40	119.00	164.80	150.00	97.00
2½"	11.00	8.00	59.00	131.60	45.50	139.50	197.20	162.00	110.00
3"	11.00	8.00	76.00	178.80	42.80	180.00	230.40	200.40	139.00

Inlet connector - threaded female / outlet connector - threaded female

size \ nom	BSP (TPI)	NPT (TPI)	DK (mm)	D (mm)	I (mm)	L (mm)	LT (mm)	E (mm)	H (mm)
1½"	11.00	11.50	39.40	94.40	32.00	76.60	148.80	121.00	88.30
2"	11.00	11.50	49.50	116.00	35.40	119.00	164.80	150.00	97.00
2½"	11.00	8.00	59.00	131.60	45.50	140.85	195.40	162.00	110.00
3"	11.00	8.00	76.00	178.80	42.80	178.10	250.00	200.40	139.00

Inlet connector - socket glued / outlet connector - socket glued

size \ nom	BSP (TPI)	NPT (TPI)	DK (mm)	D (mm)	I (mm)	L (mm)	LT (mm)	E (mm)	H (mm)
50mm	50.00	50.00	39.40	94.40	32.00	76.60	148.80	121.00	88.30
63mm	63.00	63.00	49.50	116.00	35.40	88.00	175.40	150.00	97.00
75mm	75.00	75.00	59.00	131.60	45.50	140.85	195.40	162.00	110.00
90mm	90.00	90.00	76.00	178.80	42.80	178.10	250.00	200.40	139.00

Inlet connector - socket glued / outlet connector - socket glued

size \ nom	BSP (TPI)	NPT (TPI)	DK (mm)	D (mm)	I (mm)	L (mm)	LT (mm)	E (mm)	H (mm)
1½"	48.26	48.00	39.40	94.40	32.00	76.60	148.80	121.00	88.30
2"	60.33	60.00	49.50	116.00	35.40	88.00	175.40	150.00	97.00
2½"	73.03	75.00	59.00	131.60	45.50	140.85	195.40	162.00	110.00
3"	88.90	89.00	76.00	178.80	42.80	178.10	250.00	200.40	139.00

→ **Components raw materials**

PVC ball valves 1½", 2", 2½", 3" for mining

#	Part name	Material	Qty.
1	Ring	UPVC	1
2	Socket	UPVC	1
3	Bush small o-ring	VITON	1
4	Bush	UPVC	1
5	Bush big o-ring	VITON	1
6	Seal washer*	VITON	2
7	Seal	PTFE	2
8	Ball	UPVC	1
9	Body	UPVC	1
10	Shaft	UPVC	1
11	Shaft o-ring**	VITON	1
12	Handle	PPFG	1
13	Handle logo	PPFG	1

* 3" ball valve

** 2" Model

→ **Technical dimensions**

True union ball valves 4" for mining

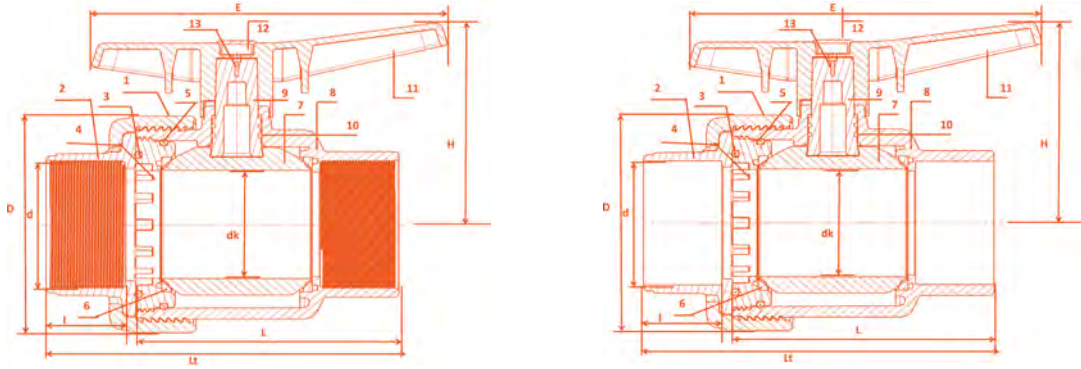

Inlet connector - threaded male / outlet connector - threaded female

size \ nom	BSP (TPI)	NPT (TPI)	DK (mm)	D (mm)	l (mm)	L (mm)	LT (mm)	E (mm)	H (mm)
4"	11.00	8.00	98.30	197.00	60.00	200.00	268.00	270.10	186.00

Inlet connector - threaded female / outlet connector - threaded female

size \ nom	BSP (TPI)	NPT (TPI)	DK (mm)	D (mm)	l (mm)	L (mm)	LT (mm)	E (mm)	H (mm)
4"	11.00	8.00	98.30	197.00	60.00	200.00	268.00	270.10	186.00

Inlet connector - socket glued / outlet connector - socket glued

size \ nom	BSP (TPI)	NPT (TPI)	DK (mm)	D (mm)	l (mm)	L (mm)	LT (mm)	E (mm)	H (mm)
110mm	110.00	110.00	98.30	196.50	60.00	200.00	268.00	270.10	186.00

Inlet connector - socket glued / outlet connector - socket glued

size \ nom	BSP (TPI)	NPT (TPI)	DK (mm)	D (mm)	l (mm)	L (mm)	LT (mm)	E (mm)	H (mm)
4"	114.30	114.00	98.30	196.50	60.00	200.00	268.00	270.10	186.00

→ **Components raw materials**

PVC ball valves 4" for mining

#	Part name	Material	Qty.
1	Ring	UPVC	1
2	Socket	UPVC	1
3	Bush small o-ring	VITON	1
4	Bush	UPVC	1
5	Bush big o-ring	VITON	1
6	Seal	PTFE	2
7	Ball	UPVC	1
8	Body	UPVC	1
9	Shaft	UPVC	1
10	Shaft o-ring	VITON	3
11	Handle	PPFG	1
12	Handle logo	PPFG	1

→ **Catalog numbers**

True union ball valves

Description	Catalog number
NMV PVC BALL VLV 1 UNION ½" FFT BSP	77450-000216
NMV PVC BALL VLV 1 UNION ¾" FFT BSP	77450-000100
NMV PVC BALL VLV 1 UNION 1" FFT BSP	77450-000101
NMV PVC BALL VLV 1 UNION 1¼" FFT BSP	77450-000102
NMV PVC BALL VLV 1 UNION 1½" FFT BSP	77450-000103
NMV PVC BALL VLV 1 UNION 2" FFT BSP	77450-000104
NMV PVC BALL VLV 1 UNION 2½" FFT BSP	77450-000105
NMV PVC BALL VLV 1 UNION 3" FFT BSP	77450-000106
NMV PVC BALL VLV 1 UNION 4" FFT BSP	77450-000107
NMV PVC BALL VLV 1 UNION ½" FFT NPT	77450-000217
NMV PVC BALL VLV 1 UNION ¾" FFT NPT	77450-000208
NMV PVC BALL VLV 1 UNION 1" FFT NPT	77450-000209
NMV PVC BALL VLV 1 UNION 1¼" FFT NPT	77450-000210
NMV PVC BALL VLV 1 UNION 1½" FFT NPT	77450-000211
NMV PVC BALL VLV 1 UNION 2" FFT NPT	77450-000212
NMV PVC BALL VLV 1 UNION 2½" FFT NPT	77450-000213
NMV PVC BALL VLV 1 UNION 3" FFT NPT	77450-000214
NMV PVC BALL VLV 1 UNION 4" FFT NPT	77450-000215
NMV PVC BALL VLV 1 UNION ½" FMT BSP	77450-000218
NMV PVC BALL VLV 1 UNION ¾" FMT BSP	77450-000120
NMV PVC BALL VLV 1 UNION 1" FMT BSP	77450-000121
NMV PVC BALL VLV 1 UNION 1¼" FMT BSP	77450-000122
NMV PVC BALL VLV 1 UNION 1½" FMT BSP	77450-000123
NMV PVC BALL VLV 1 UNION 2" FMT BSP	77450-000124
NMV PVC BALL VLV 1 UNION 2½" FMT BSP	77450-000125
NMV PVC BALL VLV 1 UNION 3" FMT BSP	77450-000126
NMV PVC BALL VLV 1 UNION 4" FMT BSP	77450-000127
NMV PVC BALL VLV 1 UNION ½" FMT NPT	77450-000219
NMV PVC BALL VLV 1 UNION ¾" FMT NPT	77450-000149
NMV PVC BALL VLV 1 UNION 1" FMT NPT	77450-000150
NMV PVC BALL VLV 1 UNION 1¼" FMT NPT	77450-000152
NMV PVC BALL VLV 1 UNION 1½" FMT NPT	77450-000153
NMV PVC BALL VLV 1 UNION 2" FMT NPT	77450-000151
NMV PVC BALL VLV 1 UNION 2½" FMT NPT	77450-000154
NMV PVC BALL VLV 1 UNION 3" FMT NPT	77450-000155
NMV PVC BALL VLV 1 UNION 4" FMT NPT	77450-000156

Description	Catalog number
NMV PVC BALL VLV 1 UNION 20MM SG ISO/D	77450-000220
NMV PVC BALL VLV 1 UNION 25MM SG ISO/D	77450-000200
NMV PVC BALL VLV 1 UNION 32MM SG ISO/D	77450-000201
NMV PVC BALL VLV 1 UNION 40MM SG ISO/D	77450-000202
NMV PVC BALL VLV 1 UNION 50MM SG ISO/D	77450-000203
NMV PVC BALL VLV 1 UNION 63MM SG ISO/D	77450-000204
NMV PVC BALL VLV 1 UNION 75MM SG ISO/D	77450-000205
NMV PVC BALL VLV 1 UNION 90MM SG ISO/D	77450-000206
NMV PVC BALL VLV 1 UNION 110MM SG ISO/D	77450-000207
NMV PVC BALL VLV 1 UNION ½" SG BS	77450-000221
NMV PVC BALL VLV 1 UNION ¾" SG BS	77450-000360
NMV PVC BALL VLV 1 UNION 1" SG BS	77450-000361
NMV PVC BALL VLV 1 UNION 1¼" SG BS	77450-000362
NMV PVC BALL VLV 1 UNION 1½" SG BS	77450-000108
NMV PVC BALL VLV 1 UNION 2" SG BS	77450-000350
NMV PVC BALL VLV 1 UNION 2½" SG BS	77450-000109
NMV PVC BALL VLV 1 UNION 3" SG BS	77450-000110
NMV PVC BALL VLV 1 UNION 4" SG BS	77450-000367
NMV PVC BALL VLV 1 UNION ½" SG ASTM	77450-000380
NMV PVC BALL VLV 1 UNION ¾" SG ASTM	77450-000381
NMV PVC BALL VLV 1 UNION 1" SG ASTM	77450-000382
NMV PVC BALL VLV 1 UNION 1¼" SG ASTM	77450-000383
NMV PVC BALL VLV 1 UNION 1½" SG ASTM	77450-000384
NMV PVC BALL VLV 1 UNION 2" SG ASTM	77450-000385
NMV PVC BALL VLV 1 UNION 2½" SG ASTM	77450-000386
NMV PVC BALL VLV 1 UNION 3" SG ASTM	77450-000387
NMV PVC BALL VLV 1 UNION 4" SG ASTM	77450-000388

→ **Catalog numbers**

Polypropylene true union ball valves

Description	Catalog number
NMV PP BALL VLV 1 UNION ¾" FFT BSP	77449-000101
NMV PP BALL VLV 1 UNION 1" FFT BSP	77449-000102
NMV PP BALL VLV 1 UNION 1¼" FFT BSP	77449-000103
NMV PP BALL VLV 1 UNION 1½" FFT BSP	77449-000104
NMV PP BALL VLV 1 UNION 2" FFT BSP	77449-000105
NMV PP BALL VLV 1 UNION 2½" FFT BSP	77449-000106
NMV PP BALL VLV 1 UNION 3" FFT BSP	77449-000107
NMV PP BALL VLV 1 UNION 4" FFT BSP	77449-000108
NMV PP BALL VLV 1 UNION ¾" FFT NPT	77449-000131
NMV PP BALL VLV 1 UNION 1" FFT NPT	77449-000132
NMV PP BALL VLV 1 UNION 1¼" FFT NPT	77449-000133
NMV PP BALL VLV 1 UNION 1½" FFT NPT	77449-000134
NMV PP BALL VLV 1 UNION 2" FFT NPT	77449-000135
NMV PP BALL VLV 1 UNION 2½" FFT NPT	77449-000136
NMV PP BALL VLV 1 UNION 3" FFT NPT	77449-000137
NMV PP BALL VLV 1 UNION 4" FFT NPT	77449-000138
NMV PP BALL VLV 1 UNION ¾" FMT BSP	77449-000151
NMV PP BALL VLV 1 UNION 1" FMT BSP	77449-000152
NMV PP BALL VLV 1 UNION 1¼" FMT BSP	77449-000153
NMV PP BALL VLV 1 UNION 1½" FMT BSP	77449-000154
NMV PP BALL VLV 1 UNION 2" FMT BSP	77449-000155
NMV PP BALL VLV 1 UNION 2½" FMT BSP	77449-000156
NMV PP BALL VLV 1 UNION 3" FMT BSP	77449-000157
NMV PP BALL VLV 1 UNION 4" FMT BSP	77449-000158
NMV PP BALL VLV 1 UNION ¾" FMT NPT	77449-000171
NMV PP BALL VLV 1 UNION 1" FMT NPT	77449-000172
NMV PP BALL VLV 1 UNION 1¼" FMT NPT	77449-000173
NMV PP BALL VLV 1 UNION 1½" FMT NPT	77449-000174
NMV PP BALL VLV 1 UNION 2" FMT NPT	77449-000175
NMV PP BALL VLV 1 UNION 2½" FMT NPT	77449-000176
NMV PP BALL VLV 1 UNION 3" FMT NPT	77449-000177
NMV PP BALL VLV 1 UNION 4" FMT NPT	77449-000178

Description	Catalog number
NMV PP BALL VLV 1 UNION 25MM SG ISO/D	77449-000201
NMV PP BALL VLV 1 UNION 32MM SG ISO/D	77449-000202
NMV PP BALL VLV 1 UNION 40MM SG ISO/D	77449-000203
NMV PP BALL VLV 1 UNION 50MM SG ISO/D	77449-000204
NMV PP BALL VLV 1 UNION 63MM SG ISO/D	77449-000205
NMV PP BALL VLV 1 UNION 75MM SG ISO/D	77449-000206
NMV PP BALL VLV 1 UNION 90MM SG ISO/D	77449-000207
NMV PP BALL VLV 1 UNION 110MM SG ISO/D	77449-000208
NMV PP BALL VLV 1 UNION ¾" SG ASTM	77449-000221
NMV PP BALL VLV 1 UNION 1" SG ASTM	77449-000222
NMV PP BALL VLV 1 UNION 1¼" SG ASTM	77449-000223
NMV PP BALL VLV 1 UNION 1½" SG ASTM	77449-000224
NMV PP BALL VLV 1 UNION 2" SG ASTM	77449-000225
NMV PP BALL VLV 1 UNION 2½" SG ASTM	77449-000226
NMV PP BALL VLV 1 UNION 3" SG ASTM	77449-000227
NMV PP BALL VLV 1 UNION 4" SG ASTM	77449-000228
NMV PP BALL VLV 1 UNION ¾" SG BS	77449-000241
NMV PP BALL VLV 1 UNION 1" SG BS	77449-000242
NMV PP BALL VLV 1 UNION 1¼" SG BS	77449-000243
NMV PP BALL VLV 1 UNION 1½" SG BS	77449-000244
NMV PP BALL VLV 1 UNION 2" SG BS	77449-000245
NMV PP BALL VLV 1 UNION 2½" SG BS	77449-000246
NMV PP BALL VLV 1 UNION 3" SG BS	77449-000247
NMV PP BALL VLV 1 UNION 4" SG BS	77449-000248

Angle Seat "Y" Valves

Experience seamless flow, low-pressure loss, and robust construction. With multi-turn linear motion and durable engineering plastic, precision and simplicity unite for unparalleled mining performance. Elevate your control with our efficient solution.



High durability



Very high efficiency



Extremely versatile

/ Benefits & Features

- **High performance** Flow is minimally impeded in the open position, resulting in excellent flow rate and a low-pressure loss.
- **Super efficient** Quarter turn shut off valve, threaded, user-friendly design allowing smooth handle operation and easily controls your flow.
- **Extremely resistant** Corrosion and chemical resistant: thanks to Viton seals and UV-stable exterior materials, this product stands strong against corrosive substances and harsh chemicals.

/ Specifications

- Operating pressure range – up to 10 bars (PN10).
- High strength Polypropylene.
- 2" BSP or NPT male threaded.
- Manual, hand operated.
- Recommended flow – up to 50 m³/h.
- High quality Nitrile seal.

→ **Technical dimensions**

Inlet - threaded male / outlet connector - threaded male

Size	Nom	BSP (TPI)	NPT (TPI)	A (mm)	B (mm)	C* (mm)	C1** (mm)
2"		11.00	11.50	252.0	200.0	254.0	292.0

* When valve is fully closed
 ** When valve is fully opened

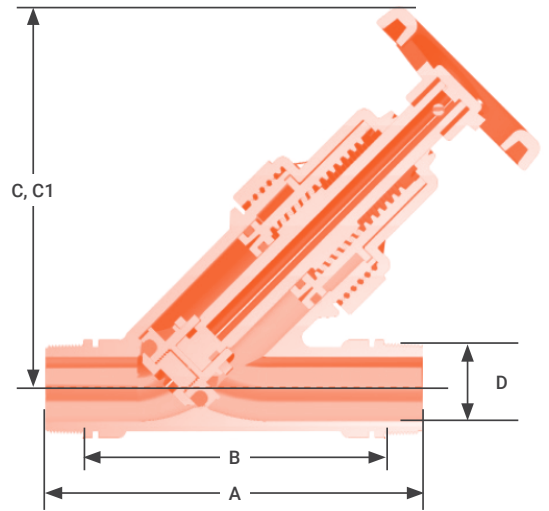

→ **Packaging data**

Model	Quantity p/box (units)	Box sizes (cm x cm x cm)	Box weight (kg)	Boxes p/pallet
2"	2	39.5 x 36.5 x 14.5	2.8	63

→ **Components raw materials**

Angle seat "Viton" version

#	Part name	Material	Quantity
1	Body	PP	1
2	Seal cup lock	PP	1
3	Seal	VITON	1
4	Seal cup	PP	1
5	Lock clip	PP	1
6	Stem housing o-ring (outer)	VITON	1
7	Stem housing o-ring (inner)	VITON	1
8	Stem housing	PP	1
9	Shaft	PP	1
10	Cap	PP	1
11	Lock pin	PP	1
12	Throttle wheel (purple color)	PP	1

PP = Polypropylene

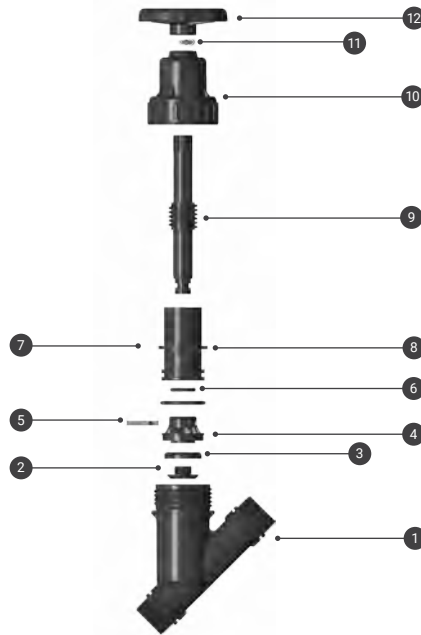

→ **Head loss**

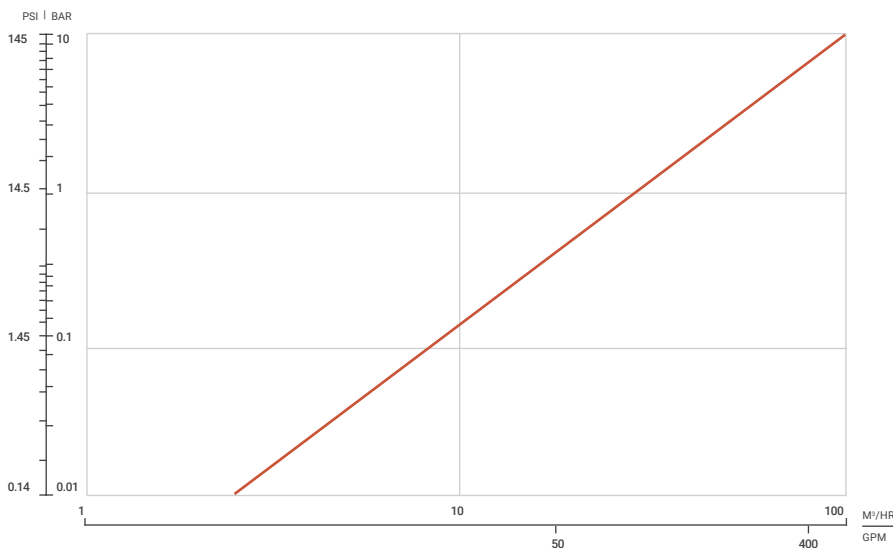

→ **Catalog numbers**

Product illustration	Product description	Catalog number
	NMV PP ANGLE SEAT "Y" 2" BSP	77457-000100
	NMV PP ANGLE SEAT "Y" 2" NPT	77457-000101
	NMV PP ANGLE SEAT "Y" 2" BSP VITON	77457-000102
	NMV PP ANGLE SEAT "Y" 2" NPT VITON	77457-000103

* Additional diameters are available upon request

PVC Butterfly Valves

Physical shut off, manual restriction, control or service needs, for any fluid conveyance system.



User friendly



Saving on system cost



High durability

/ Benefits & Features

- **Smooth operation** Quarter turn shut-off valve and user-friendly design for smooth handle operation.
- **Easy installation and maintenance** Lightweight and very easy to install between two flanges, at any position, saves labor costs and multiple investments in maintenance.
- **Ultimate durability** Highly reliable operation and durability over time. Corrosion-resistant and UV-stable components.

/ Specifications

- Ergonomic multifunctional handle enabling quick operation, with 15 degrees' adjustment graduations.
- Drilling pattern with oval slots allowing coupling to flanges and complying with numerous international standards.
- Can also be installed as an end line valve, bottom discharge valve or tank dump valve.
- Maximum working pressure 10 bar.
- One-piece body made of PVC-U.
- Disc designed ensuring low torque and low head loss.
- Suitable for piping in a limited space: 46 mm (models 2", 2½", 3") and 56 mm (model 4").

→ Packaging data

Model	Quantity p/box (units)	Box sizes (cm x cm x cm)	Box weight (kg)	Boxes p/pallet
2"	2	39.5 x 28.5 x 13.0	2.98	48
2½"			3.40	
3"			3.73	
4"		40.0 x 37.5 x 13.5	5.79	30

→ Technical dimensions

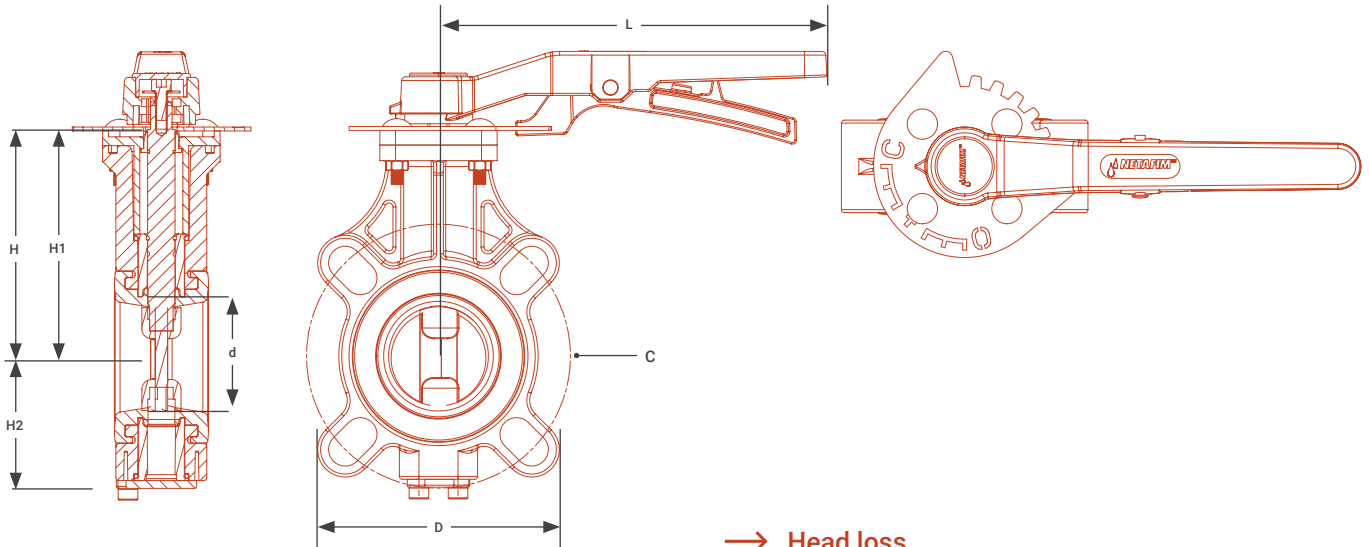

Size	2"	2½"	3"	4"
Nom				
d	50	65	80	100
D	117	112	128	162
H1	130	134	144	152
H2	71	88	91	106
H	165	174	182	197
L	198.5	198.5	198.5	279.0
C(POD)	120.8	137.5	155.5	183.0

→ Head loss

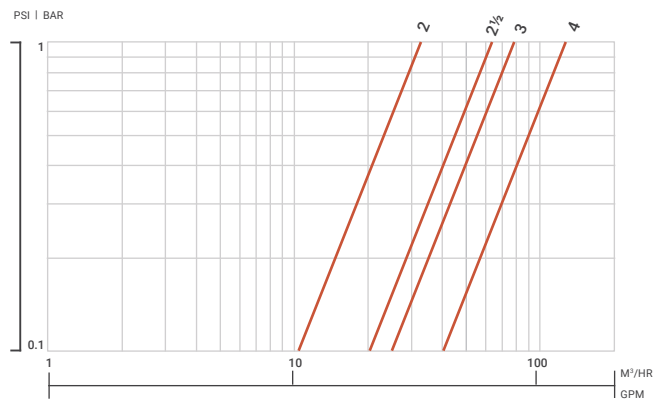

→ Catalog numbers

Product illustration	Product description	Catalog number
	NMV PVC B.FLY VLV 2" 4 S BTW FLNG	77452-000100
	NMV PVC B.FLY VLV 2½" 4 S BTW FLNG	77452-000101
	NMV PVC B.FLY VLV 3" 4 S BTW FLNG	77452-000102
	NMV PVC B.FLY VLV 4" 4/8 S BTW FLNG	77452-000103

Metal Butterfly Valves

Simple, light and reliable for installation wherever there is a need to cut the flow passage in pipes and systems.



Superb quality



High durability



Extremely versatile

/ Benefits & Features

- **Superb quality** Manual valves manufactured using the highest quality materials, complying with the standards for hydraulically operated devices.
- **Ultimated durability** High-quality butterfly valves offer excellent resistance over time. Replaceable seat guarantees bidirectional water tightness and easy maintenance due to their innovative design and long-life valve.
- **Extremely versatile** Various disc material options are available: ductile iron, stainless steel or aluminum bronze.

/ Specifications

- Type concentric.
- Pressure grade PN16.
- Working pressure 16 bar.
- Available diameters DN50 to DN600.
- Working temperature 0°C to 80°C .
- Connection wafer.
- Coating fusion bonded epoxy 250 µm.

* Other materials and specifications on request.

→ Technical dimensions for body

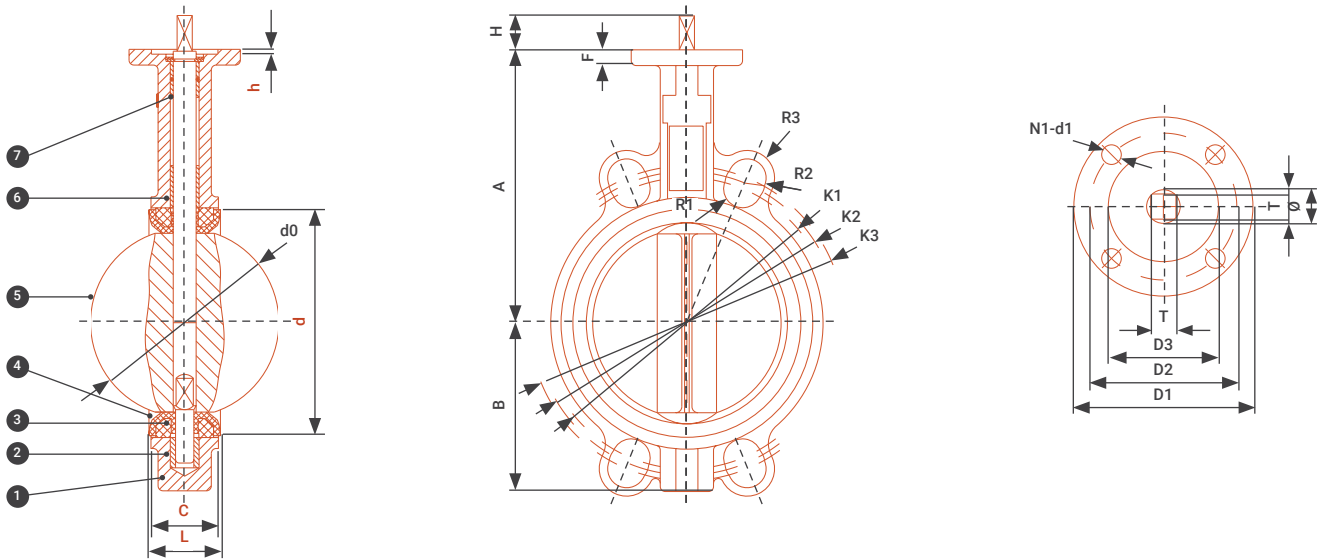

dn	A	B	h	d0	c	l	d	k1	k2	k3	r1	r2	r3	f	d1	d2	d3	h	4-d1	Ø	t
50	125	73	28	52.6	43	46	73.3	120.6	125	124	10.5	-	10.5	10	65	50	35	4	7	12.6	9
65	136	82	28	64.3	46	49	86.0	139.7	145	145	10.5	-	10.5	10	65	50	35	4	7	12.6	9
80	142	91	28	78.8	46	49	100.9	152.4	160	160	10.5	-	10.5	10	65	50	35	4	7	12.6	9
100	163	107	28	104	52	55	132	180	180	190.5	10.5	-	10.5	12	90	70	55	4	10	15.77	11
125	176	127	28	123.3	56	59	156	210	210	215.9	12.2	-	12.2	12	90	70	55	4	10	18.92	14
150	197	143	28	155.7	56	59	185.4	240	240	241.3	12.2	-	12.2	12	90	70	55	4	10	18.92	14
200	230	170	38	202.4	60	64	235.2	295	295	298.5	12.2	12.5	12.2	15	125	102	70	4	12	22.1	17
250	260	204	38	250.4	68	72	289.4	350	355	361.9	13.7	15	13.7	15	125	102	70	4	12	28.45	22
300	292	240	38	301.5	78	82	341.2	400	410	431.8	13.7	15	13.7	15	125	102	70	4	12	31.6	22

→ Components raw materials

#	Part name	Material	Specification
1	Body	Ductile Iron	GGG40
2	Shaft	Stainless Steel	AISI 420
3	Disc	Stainless Steel	AISI 316
4	Seat	EPDM	EN681
5	Bearing	PFTE	Commercial
6	Ring seal	EPDM	EN681
7	Indicator plate	Stainless Steel	AISI 420

→ Technical dimensions for lever

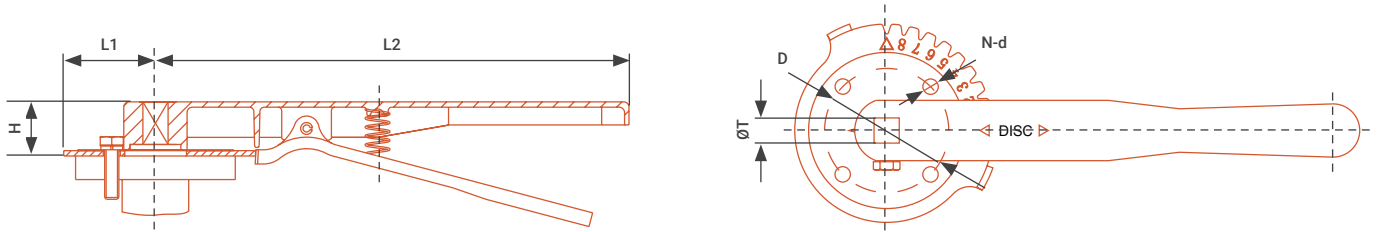

dn	h	l1	l2	d	N-d	ØT
50	28	52	267	50	4-7	9
65	28	52	267	50	4-7	9
80	28	52	267	50	4-7	9
100	28	52	267	70	4-10	11
125	28	52	267	70	4-10	14
150	28	52	267	70	4-10	14
200	38	75	359	102	4-12	17
250	38	75	359	102	4-12	22
300	38	75	359	102	4-12	22

→ Technical dimensions for gearbox

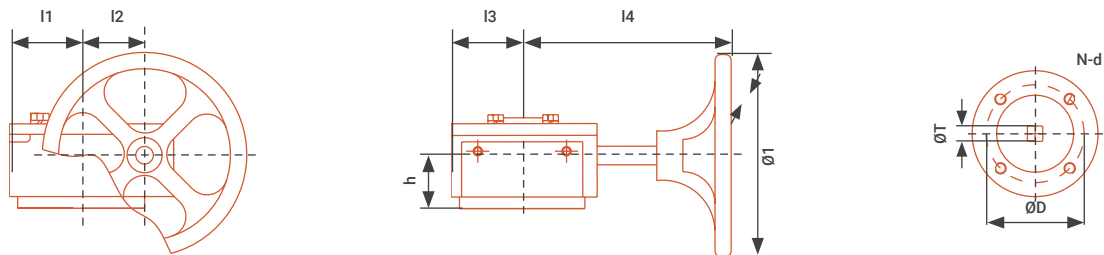

dn	h	l1	l2	l3	l4	Ø1	d1	N-d	ØT
50	35	51	43	51	151	154	50	4-m6	9
65	35	51	43	51	151	145	50	4-m6	9
80	35	51	43	51	151	145	50	4-m6	9
100	35	51	43	51	151	145	70	4-m8	11
125	35	51	43	51	151	145	70	4-m8	14
150	35	51	43	51	151	145	70	4-m8	14
200	42	72	65	72	210	285	102	4-m10	17
250	42	72	65	72	210	285	102	4-m10	22
300	45	94	79	94	190	285	102	4-m10	22

→ Catalog numbers

Description	Catalog number
Gaer butterfly valve 2" lever - SST disc	71660-000970
Gaer butterfly valve 3" lever - SST disc	71660-000971
Gaer butterfly valve 4" lever - SST disc	71660-000972
Gaer butterfly valve 6" lever - SST disc	71660-000973
Gaer butterfly valve 8" lever - SST disc	71660-000974
Gaer butterfly valve 10" lever - SST disc	71660-000975
Gaer butterfly valve 2" gear - SST disc	71660-000980
Gaer butterfly valve 3" gear - SST disc	71660-000981
Gaer butterfly valve 4" gear - SST disc	71660-000982
Gaer butterfly valve 6" gear - SST disc	71660-000983
Gaer butterfly valve 8" gear - SST disc	71660-000984
Gaer butterfly valve 10" gear - SST disc	71660-000985

* Additional diameters, materials and specifications are available upon request.

Air Valves



DG10 / D40

The combination air valve has the features of both an air release valve and an air and vacuum valve. The air release component is designed to automatically release small pockets of air to the atmosphere as they accumulate at peaks or along a pipeline or piping system when it is full and operating under pressure.



Maximum
reliability



Superior
design



Ease of
operation

/ Benefits & Features

- **Maximum reliability** Reduces water hammer incidents.
- **Superior design** Allows for high velocity air discharge while preventing premature closure.
- **Ease of operation** Lightweight, simple and reliable structure.
- **Discharge outlet** The discharge outlet enables removal of excess fluids.
- **Automatic air release** The large size of the automatic air release orifice relative to the air valve body:
Discharges air at high flow rates.
Lessens the danger of its obstruction by debris.
Enables the usage of the patented rolling seal mechanism, making it less sensitive to pressure differential than a direct float seal.

/ Specifications

- Working pressure range DG10: 0.1-10 bar / D40: 0.2-16 bar
- Testing pressure DG10: 16 bar / D40: 25 bar
- Maximum working temperature 60°C
- The body is made of high-strength composite materials and all operating parts are made of specially selected, corrosion-resistant materials.
- Due to its light weight, the valve may be installed on plastic piping systems, as well as other lightweight piping systems.

→ Technical dimensions

Nominal Size	Dimensions (mm)		Air release (mm)	Weight (kg)	Orifice area (mm ²)	
	A	B	C		auto	a/v
1/2", 3/4", 1"	100	143	3/8" BSP female	0.33	7.8	100
2"	183	215	1 1/2" BSP female	1.10	12	804

1/2", 3/4", 1" Model

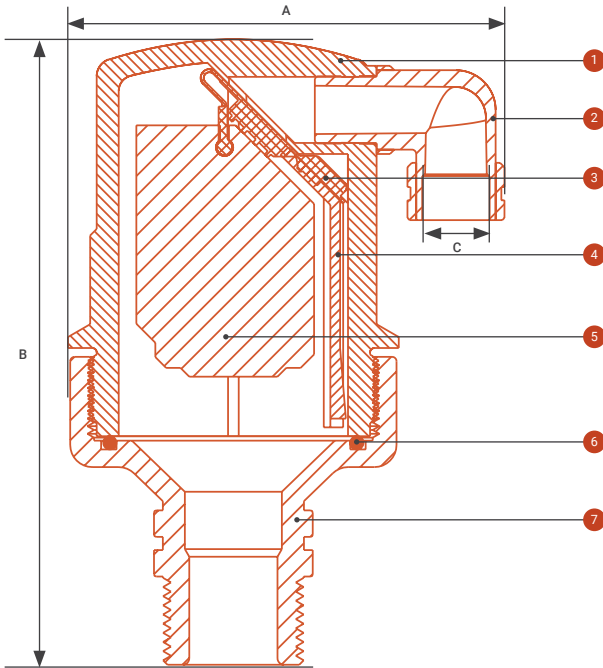

2" Model

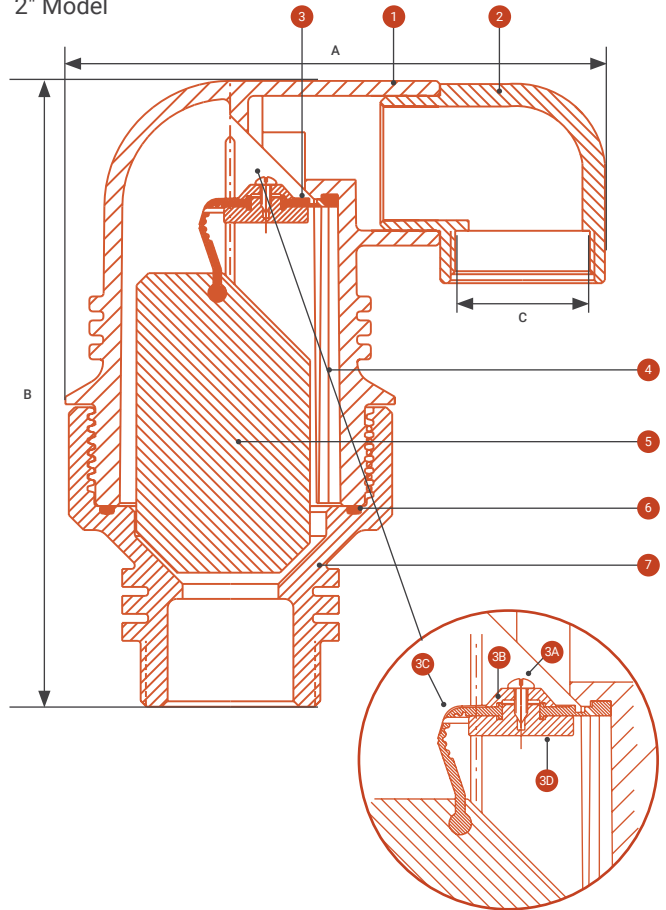

→ Components raw materials

#	Part name	Material
1	Body	Reinforced nylon
2	Discharge outlet	Polypropylene
3	1/2", 3/4", 1" Rolling seal	EPDM
2" rolling seal assembly:		
3a	Screws	Stainless steel 304
3b	Plug cover	Reinforced nylon
3c	Rolling seal	EPDM
3d	Plug	Reinforced nylon
4	Clamping stem	Reinforced nylon
5	Float	Foamed polypropylene
6	O-ring	Buna-n
7	Base	Reinforced nylon / brass / stainless steel 316
8	Optional: ball valves	Brass nickel plated

→ **Head Loss**

Air & Vacuum Flow Rate

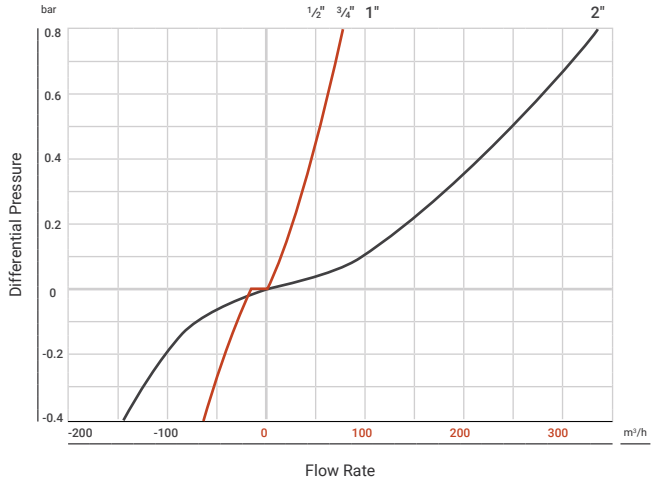

GD10 / PN 10 Automatic Air Release Flow Rate

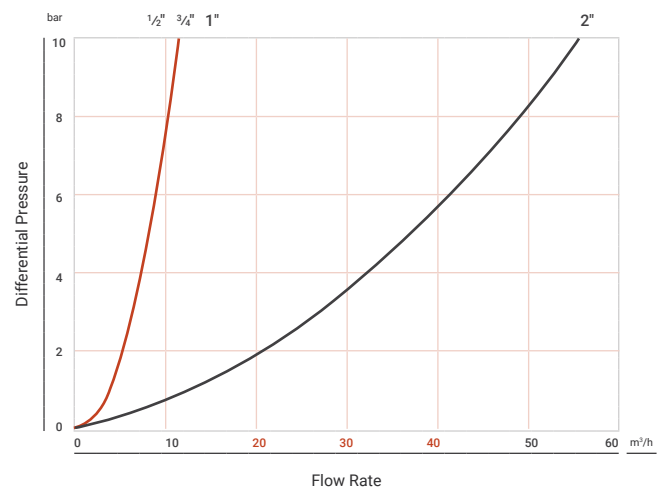

D40 / PN 16 Automatic Air Release Flow Rate

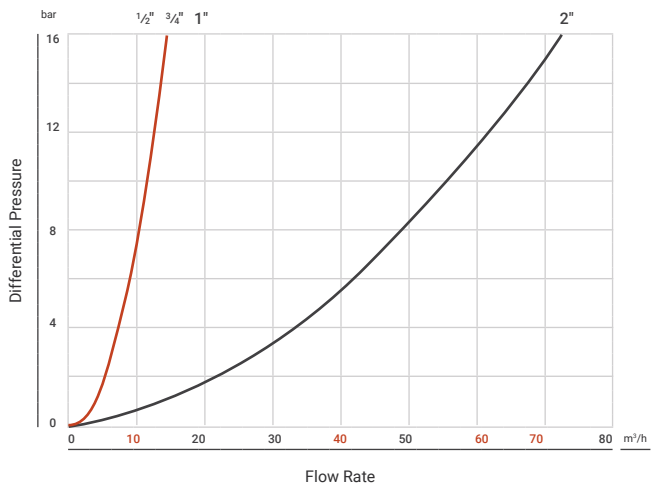

→ **Catalog numbers**

Model	Diameter	Connection	Max, working pressure (bar)	Catalog number
DG10	3/4"	BSP	10	70500-000520
		NPT	10	70561-001050
	1"	BSP	10	70500-000650
		NPT	10	70561-001200
2"	NPT	10	70561-001660	
	BSP	10	70500-001170	
D40	3/4"	BSP	16	70500-000500
		NPT	16	70561-000850
	1"	BSP	16	70500-000600
		NPT	16	70561-001240
	2"	BSP	16	70500-001100
		NPT	16	70561-001400

→ **Catalog numbers examples**

An integrated chemical-resistant air valve, designed to improve hydraulic operation by protecting the pipeline, increasing pipeline efficiency and reducing energy requirements. generally located after the main valve and/or before the irrigation valve.

Description	Catalog number
D40 1" BSPT PP PN10 NTW NYLON BASE, VITON	70500-000640
D40 1" NPT PP PN10 VITON	70561-001220
D40 2" BSPT PP PN10 VITON, MINES	70500-001117
D40 2" BSPT PP PN10 NFR VITON	70500-001115
D40 2" BSPT STST316 PN16 PP, VITON, MINES	70500-002670
D40 2" NPT PP 150PSI NET VITON	70561-001600
D40 2" NPT PP PN10 NFR VITON	70561-001620
D40 2" NPT STST316 PN16 VITON	70561-000812

*Other configurations are available upon request

D40L

Features of both an air release valve and an air & vacuum valve in a single body. This air valve is specifically designed to operate with liquids containing small suspended solids.



High durability



Light



Superior design

/ Benefits & Features

- **High durability** Lightweight, simple, and reliable structure.
Body and all operating parts are made of specially selected, corrosion-resistant materials.
- **Light** Enables valve to be installed on plastic piping systems or other lightweight piping systems.
- **Superior design** Allows for high-capacity air discharge while preventing premature closure.
Discharge outlet enables the connection of a vent pipe.
The large size of the automatic air release orifice relative to the air valve body releases air at high flow rates, lessens the danger of its obstruction by debris, and the valve's rolling seal mechanism design is less sensitive to different pressures than a direct float seal.
Air gap building separates the liquids with suspended particles from the sealing mechanism.

/ Specifications

- Working pressure range:
Polypropilene: 10 bar
Reinforced nylon, PVDF, Duplex, SST; 16 bar
- Testing pressure 1.5 times the maximum working pressure
- Maximum working temperature 60°C
- Maximum intermittent temperature 90°C

→ **Technical dimensions**

PP / Nylon / PVDF

Model 1/2", 3/4", 1"	Dimensions (mm)		Air release	Weight (gr)	Orifice area (mm ²)	
	A	B	C		auto	a/v
PP / NYLON / PVDF	99	227	3/8" BSP female	0.6	100	7.8
SST / Duplex	94	216	3/8" BSPT female	1.7	100	7.8

→ **Components raw materials**

PP / Nylon / PVDF

#	Part name	Material
1	Body	Polypropylene / Reinforced nylon / PVDF
2	O-ring	Buna-n / Viton / EPDM
3	Discharge outlet	Polypropylene
4	Rolling seal	EPDM / Viton
5	Clamping stem	Polypropylene
6	Float	Foamed polypropylene
7	O-ring	Buna-n / Viton / EPDM
8	Extension	Polypropylene / Reinforced nylon / PVDF
9	Closed port* (default)	
10	Base	Polypropylene / Reinforced nylon / PVDF
11	O-ring	Buna-n / Viton

* Optional: Open Port / Schrader Valve / Plug

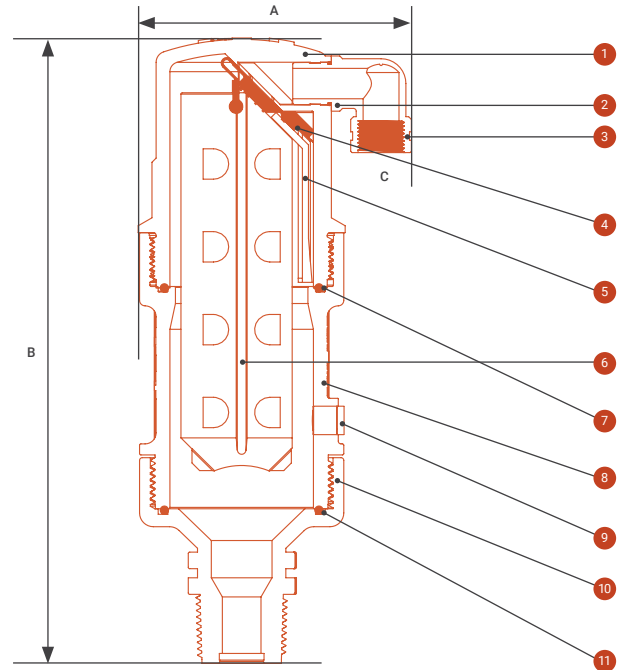

SST / Duplex

#	Part name	Material
1	Cover	Stainless steel 316 / Duplex
2	Air release outlet	Polypropylene
3	O-ring	Buna-n / Viton / EPDM
4	Rolling seal	EPDM / Viton
5	Clamping stem	Reinforced nylon
6	Extension	Stainless steel 316 / Duplex
7	Float	Foamed polypropylene
8	O-ring	Buna-n / Viton / EPDM
9	Body	Stainless steel 316 / Duplex

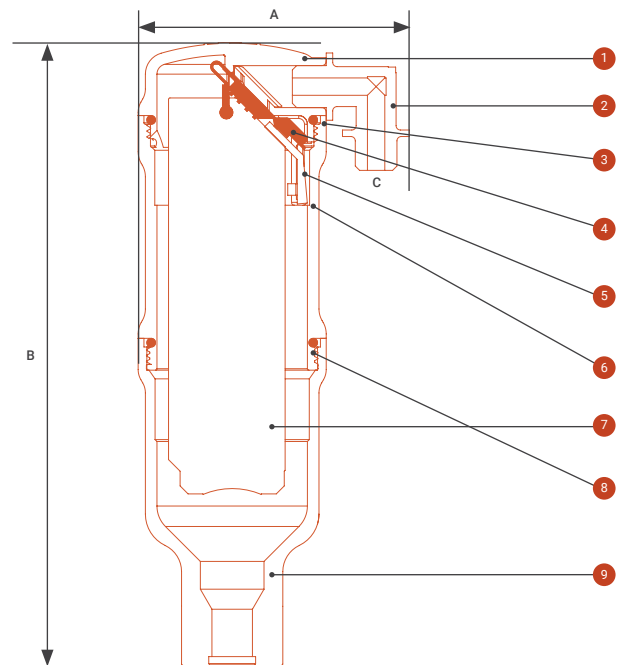

→ Technical dimensions

2"

Size	Dimensions (mm)		Air release	Weight (gr)	Orifice area (mm ²)	
	A	B	C		auto	a/v
2"	99	227	3/8" BSP female	0.6	100	7.8

→ Components raw materials

2"

#	Part name	Material
1	Body	Polypropylene / Reinforced nylon / Stainless steel 316 / PVDF
2	O-ring	Buna-n / Viton
3	Discharge outlet	Polypropylene
4	Rolling seal assembly	
4a	Screws	Stainless steel
4b	Plug cover	Reinforced nylon
4c	Rolling seal	EPDM
4d	Plug	Reinforced nylon
5	Clamping stem	Polypropylene
6	Float	Foamed polypropylene
7	O-ring	Buna-n / Viton
8	Extension	Polypropylene / Reinforced nylon / Stainless steel 316 / PVDF
9	Closed port* (default)	
10	Base	Polypropylene / Reinforced nylon / Stainless steel 316 / PVDF
11	O-ring	Buna-n / Viton

* Optional: open port / Schrader valve / plug

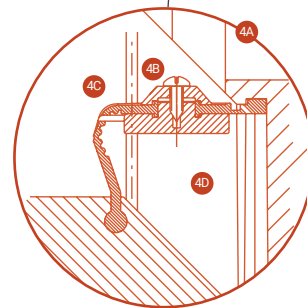
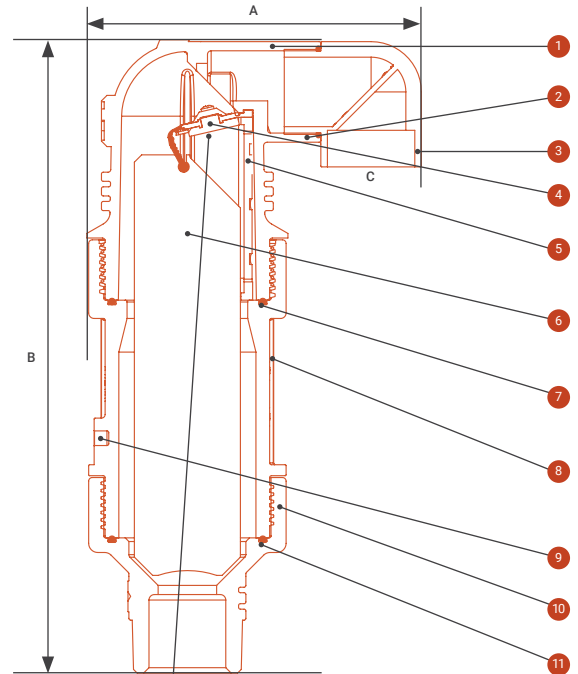

→ **Head loss**

Air & Vacuum Flow Rate

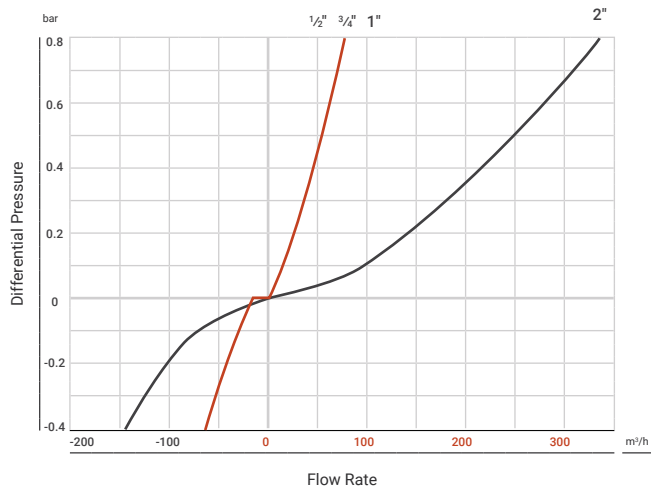

Automatic Air Release Flow Rate

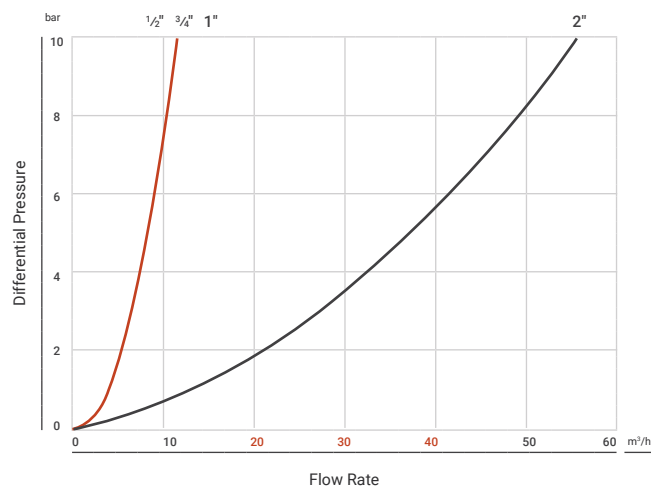

Automatic Air Release Flow Rate

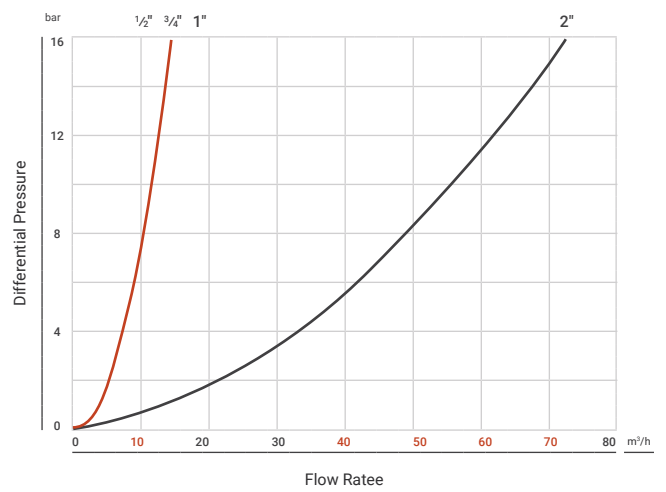

→ **Catalog numbers**

Model	Diameter	Connection	Max. working pressure	Catalog number
D40L	1/2"	NPT	10	70561-000815
	3/4"	NPT	10	70561-000050
	1"	NPT	10	70561-000060
	2"	NPT	10	70561-000100
D40LP	1"	BSP	10	70500-000590

→ **Catalog numbers examples**

An integrated chemical-resistant air valve, designed to improve hydraulic operation by protecting the pipeline, increasing pipeline efficiency and reducing energy requirements .generally located after the main valve and/or before the irrigation valve.

Description	Catalog number
D40L 1/2" NPT PP 150PSI NET VITON	70561-000815
D40L 3/4" NPT PP 150PSI NTW VITON	70561-000050
D40L 1" NPT PP 150PSI NTW VITON	70561-000060
D40L 1" NPT STST316 250PSI VITON	70561-016310
D40L 2" NPT PP PN10 VITON	70561-000100

*Other configurations are available upon request

AV10

The AV-010 air and vacuum valve discharges air at high flow rates during the filling of the system and admits air at high flow rates during drainage, pump shut-off or at water column separation.



3/4", 1" model



2" model

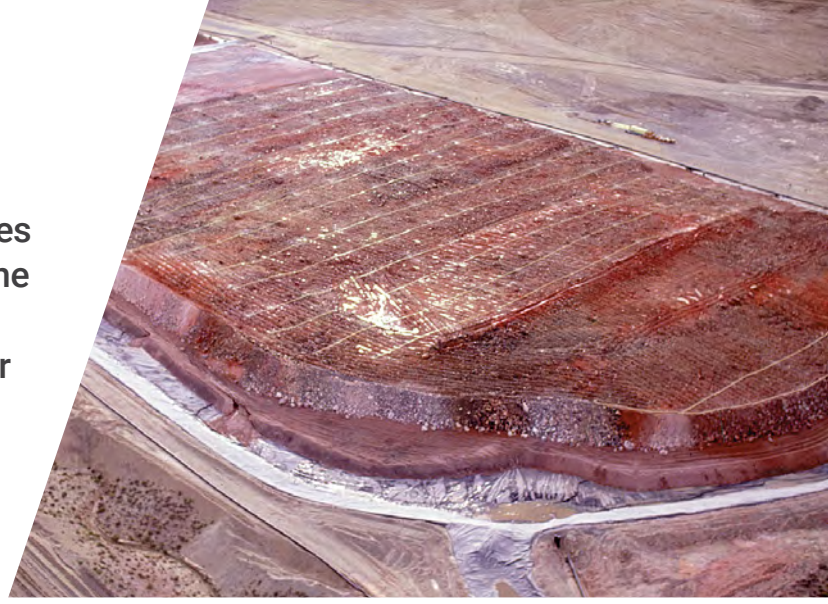

High durability



Simple operation



Maximum reliability

/ Benefits & Features

- **High durability** Made of high strength composite materials, and all operating parts are made of specially selected corrosion-resistant and UV resistant materials.
- **Simple operation** Lightweight and small dimensions.
- **Maximum reliability** For all parts.
- **Drip-tight** Sealing at low pressure.

/ Specifications

- Maximum working pressure 10 bar.
- Testing pressure 16 bar.
- Maximum working temperature 60°C.
- **Available in:**
 - 3/4" (20 mm) and 1" (25 mm) male threaded.
 - 2" (50 mm) and 3" (80 mm) female threaded.
 - NPT / BSPT.
- Optional addition – Schrader valve for measuring local line pressure (3/4", 1" only).

→ **Technical dimensions**

Nominal size	Dimensions (mm)		Weight (kg)	Orifice area (mm ²)
	A	B		
¾" (20 mm)	60	124	0.1	314
1" (25 mm)	60	124	0.1	314
2" (50 mm)	73	122	0.2	800
3" (80 mm)	104	165	0.6	2000

→ **Components raw materials**

#	Part name	¾", 1"	2"	3"
1	Cover	Polypropylene	Polypropylene	Polypropylene
2	Seal	Bunaa-n	EPDM	EPDM
3	Float	Polypropylene	Reinforced nylon	Reinforced nylon
4	Body	Polypropylene	Reinforced nylon	Reinforced nylon
5	Disc	-	Reinforced nylon	Reinforced nylon

¾", 1" Model

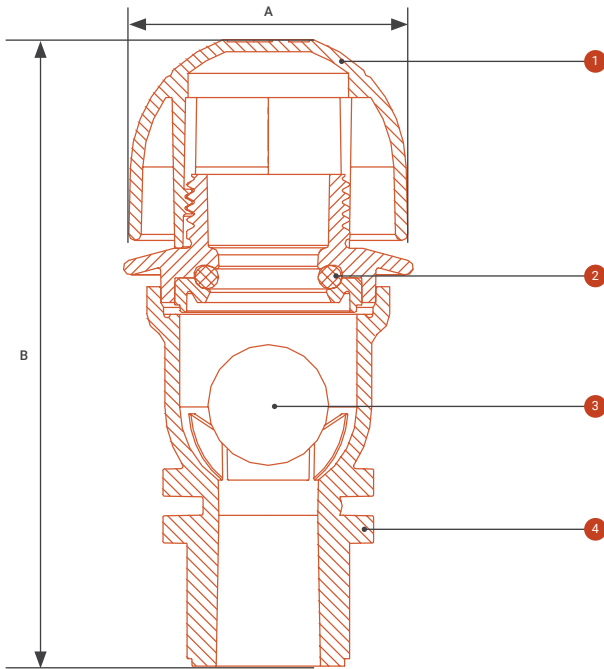

2" Model

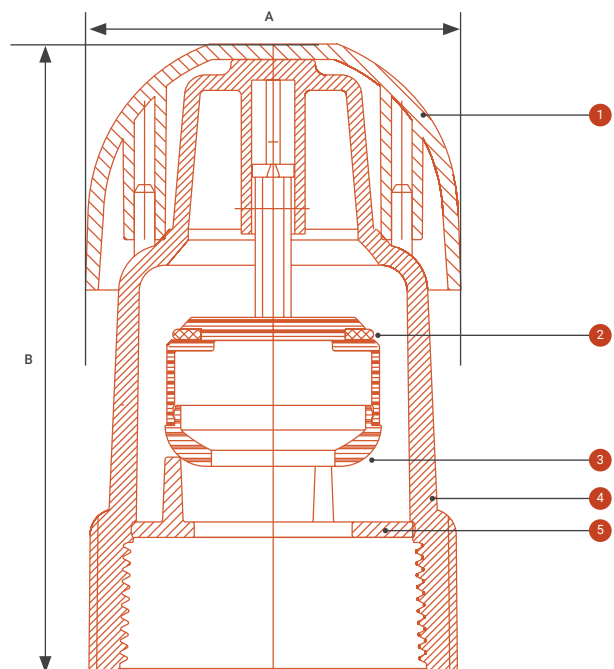

→ **Head loss**

Air & Vacuum Flow Rate

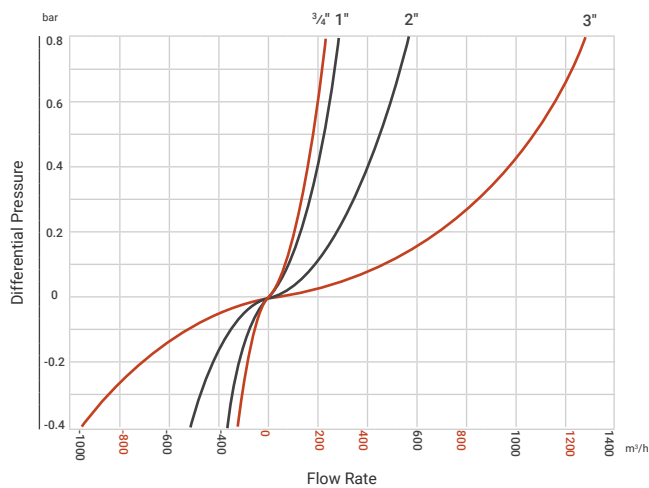

→ **Catalog numbers examples**

Valve operation includes venting air from a filling pipeline and also vacuum breaking (air intake) of a draining pipeline, to optimize pipeline hydraulic efficiency and flow.

Description	Catalog number
AV10 1" NPT PP 150PSI NET VITON	70561-004900

*Other configurations are available upon request

D20

Combination air valve installed on a mining conduction system. The air valve is designed to improve hydraulic operation by protecting the pipeline, increasing pipeline efficiency, and reducing energy requirements.

The unique body shape of the valve enables a continuous air gap that separates the water/solution from the sealing mechanism and helps to avoid deposits or blockage.

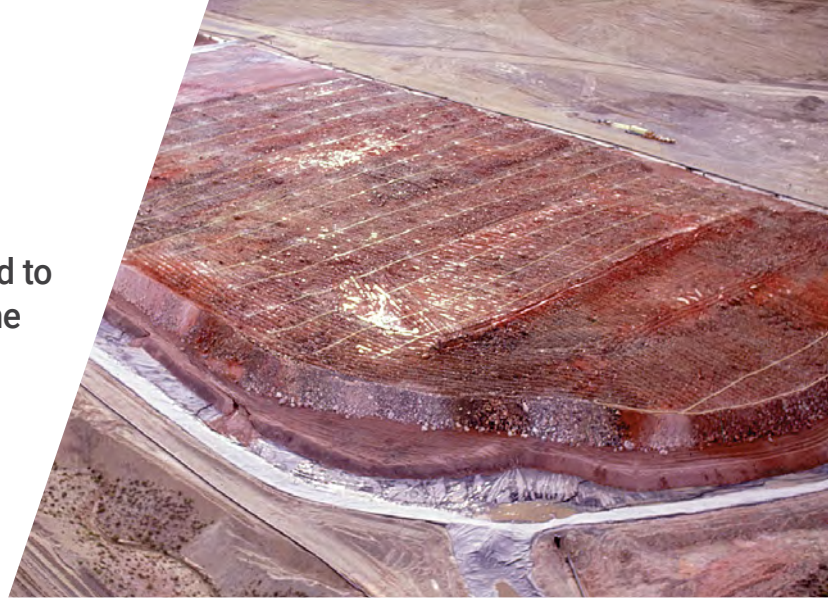

Superior design



Long lasting performance



Efficient installation

/ Benefits & Features

- **Superior design** Conical body and funnel-shaped lower body maximum air gap/ minimum body length. A continuous air gap separates the liquid from the sealing mechanism residue matter falls back into the system pipeline.
- **Long lasting performance** Float assembly and sealing mechanism linkage free movement, turbulence will not unseal the sealing mechanism. Orifice and rolling seal mechanism high-capacity air discharge, no premature closure.
- **Efficient installation** Screened threaded outlet compatible for vent pipe connection, prevents insect intrusion.
- **Leak-free** Sealing over a wide range of pressure differentials.

/ Specifications

- Size range: 2" - 8".
- Sealing pressure range: 0.05-16 bar.
- Testing pressure: 1.5 times maximum working pressure.
- Maximum working temperature: 60° C.
- Valve coating: Fusion-bonded epoxy coating in compliance with standard DIN 30677-2 (applied on Cast Steel and Cast Ductile Iron valves).
- Valve connection: flanged ends to meet various requested standards, 2" and 3" valve connections: flanged or threaded BSP/NPT.
- Standard materials: Welded/Cast steel body, optional: Stainless Steel.

→ Technical dimensions

Model	Dimensions (mm)		Air release	Weight (kg)		Orifice area (mm ²)	
	A	B	C	Steel	SST	Auto	a/v
2" THR	550	644	11/2" BSP F	16.5	15.8	12	804
2" FL	550	605	11/2" BSP F	17.5	17.0	12	804
3" THR	550	649	11/2" BSP F	16.9	16.4	12	804
3" FL	550	605	11/2" BSP F	18.5	18.5	12	804
4" FL	550	605	11/2" BSP F	19.5	19.5	12	804
6" FL	550	610	11/2" BSP F	21.0	21.0	12	804
8" FL	550	610	11/2" BSP F	24.0	22.0	12	804

FL - Flanged, THR – Threaded

All product weights and dimensions are approximate, due to the differences in flange standards, materials and variable accessories.

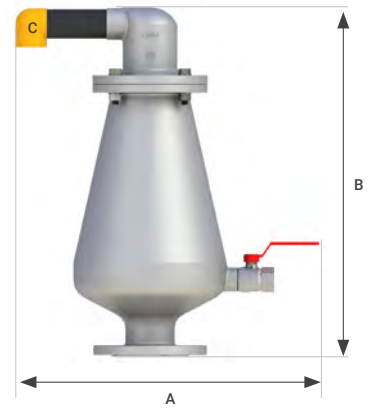

→ Components raw materials

Part	Material
Body	Reinforced Nylon
Extension	Polypropylene
Shell	Stainless Steel 316 / Super Duplex
Discharge elbow	Polypropylene
Non-slam component (optional)	Reinforced Nylon / Polypropylene / Acetal / Stainless Steel
O-ring	NBR / EPDM / Viton
Cover	Reinforced Nylon / Stainless Steel 316
Rolling seal assembly	Nylon / EPDM / Viton / Stainless Steel
Float connector	Foamed Polypropylene
Clamping stem	Reinforced Nylon
Domed nut	Stainless Steel 316
Stopper	Polypropylene
Spring	Stainless Steel 316 / Hastelloy
Float and rod	Polypropylene / Stainless Steel 316
O-ring	NBR / EPDM / Viton
Body	Stainless Steel 316 / SUPER DUPLEX
Ball Valve	Stainless Steel 316 / Super Duplex



→ Catalog numbers examples

Description	Catalog number
D20 2" MULTI STAND STST316 PN10 PPV	70520-000002
D20 2" NPT STST316 PN10 STST FLOAT PPV	70561-016030
D20 2" NPT ST37 PN16 250PSI VITON SEAL STST FLOAT FOR NAT	70561-016015
D20 2" NPT STST316 PN10 STST SHELL AND COVER PVDF PART	74480-090100
D20 2" NPT STEEL 250PSI NET VITON SEAL STST FLOAT FOR NATUR	70561-017500
D20 3" MULTI STAND STST316 PN16 VITON STST D40 AND FLOAT	70561-016160
D20 3" MULTI STAND STST316 150PSI USA STST SHELL AND COVER P	70561-000004
D20 4" ASA150 STST316 PN10 PPV STST D40	70561-016220

*Other configurations are available upon request

→ Flow charts

Air & Vacuum Flow Rate

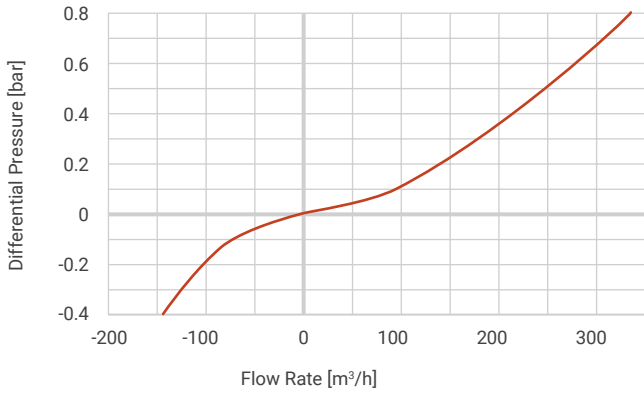

Automatic Air Release Flow Rate

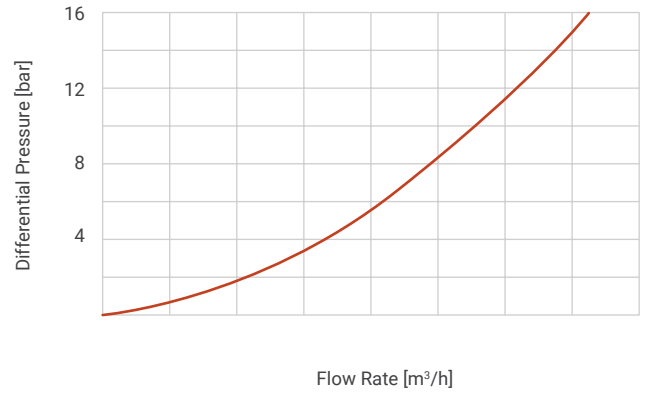

D-20 NS

Air & Vacuum Flow Rate

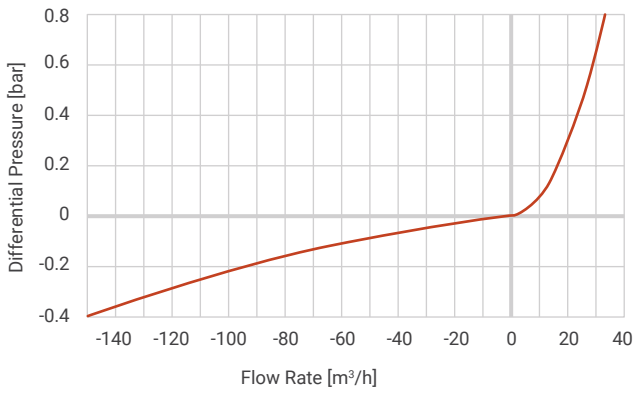

Air Discharge Flow Rate

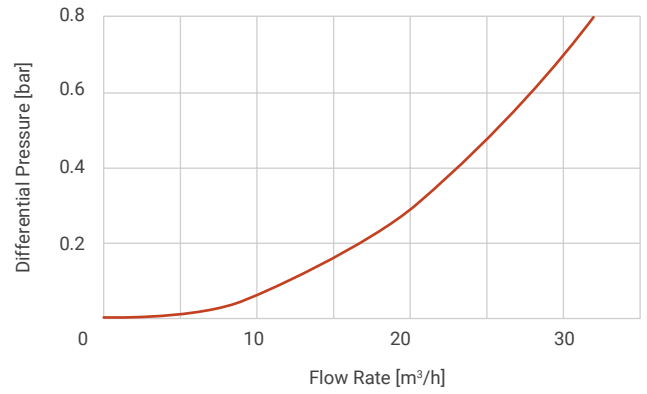

D25

This model is a reduced bore compact combination air valve. Installed on a non-clean water/solution conduction system, the air valve is designed to improve hydraulic operation by protecting the pipeline, increasing pipeline efficiency and reducing energy requirements. A continuous air gap in the valve body separates the water/solution from the sealing mechanism.

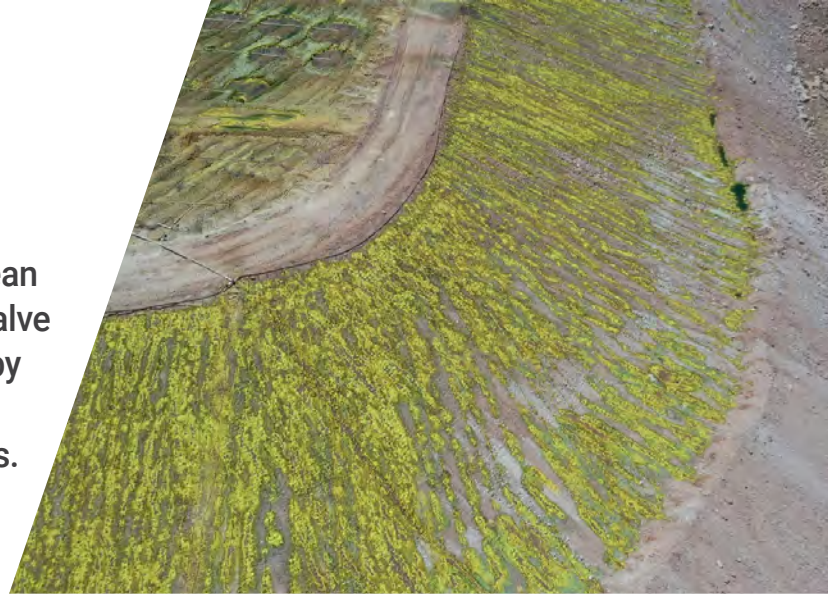

Superior design



Long lasting performance



Efficient installation

/ Benefits & Features

- **Superior design** Maximum air gap / minimum body length. A continuous air gap separates the liquid from the sealing mechanism residue matter falls back into the system pipeline.
- **Long lasting performance** Free movement, turbulence will not unseal the sealing mechanism. Residue matter falls back into the system pipeline. High-capacity air discharge, no premature closure.
- **Efficient installation** Screened threaded outlet compatible for vent pipe connection, prevents insect intrusion. Non-corrosive and durable parts
- **Leak-free** Sealing over a wide range of pressure differentials.

/ Specifications

- Size range: 2" - 4".
- Sealing pressure range: 0.05-10 bar.
- Testing pressure: 1.5 times maximum working pressure.
- Maximum working temperature: 60° C.
- Valve coating: Fusion-bonded epoxy coating in compliance with standard DIN 30677-2 (applied on Cast Steel and Cast Ductile Iron valves).
- Valve connection: Threaded male BSPT/NPT; Flanged ends to meet various requested standards.
- Standard materials: Reinforced nylon body, optional: stainless steel.

→ Technical dimensions

Model	Dimensions (mm)		Air release	Weight (kg)		Orifice area (mm ²)	
	A	B	C	Reinforced Nylon	SST	Auto	a/v
2" THR	370	455	11/2" BSP F	16.5	14.4	12	804
2" FL	370	460	11/2" BSP F	17.5	16.2	12	804
3" THR	370	455	11/2" BSP F	16.9	14.7	12	804
3" FL	370	460	11/2" BSP F	18.5	16.5	12	804
4" THR	370	455	11/2" BSP F	19.5	16.6	12	804
4" FL	370	460	11/2" BSP F	21.0	18.4	12	804

FL - Flanged, THR - Threaded

All product weights and dimensions are approximate, due to the differences in flange standards, materials and variable accessories.

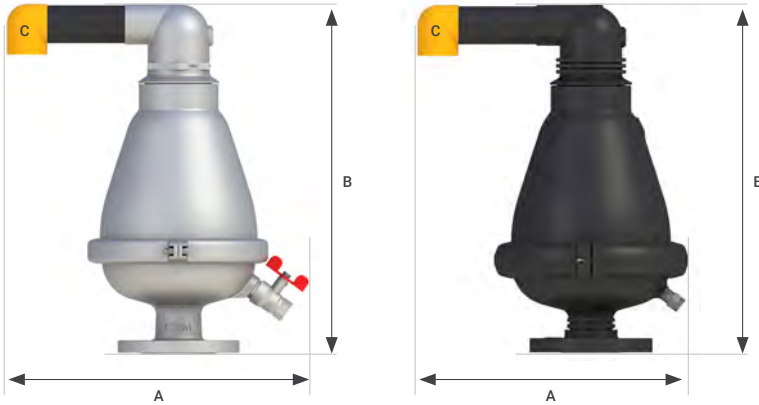

→ Components raw materials

Part	Material
Body	Stainless Steel 316
Extension	Polypropylene
Discharge elbow	Polypropylene
Camlock (optional)	Polypropylene
Non-slam component (optional)	Polypropylene / Stainless Steel
Clamping stem	Reinforced Nylon / Polypropylene
Float	Foamed Polypropylene
Screws	Stainless Steel
Plug cover	Reinforced Nylon / Polypropylene
Rolling seal	EPDM / Viton
Plug	Reinforced Nylon / Polypropylene
O-ring	NBR / EPDM / Viton
Body	Stainless Steel 316
Domed nut	Stainless Steel 316 / Super Duplex
Stopper	Polypropylene
Spring	Stainless Steel 316 / Hastelloy
Float and rod	Polypropylene / Stainless Steel 316 or Titanium
O-ring	NBR / EPDM / Viton
Clamp assembly	Stainless Steel 316
Base (threaded or flange)	Stainless Steel 316
Tap	Stainless Steel 316



→ Components raw materials

Part	Material
Body	Reinforced Nylon
Extension	Polypropylene
Discharge elbow	Polypropylene
Camlock (optional)	Polypropylene
Non-slam component (optional)	Polypropylene / Stainless Steel
Clamping stem	Reinforced Nylon / Polypropylene
Float	Foamed Polypropylene
Screws	Stainless Steel (optional electroless nickel coat)
Plug cover	Reinforced Nylon / Polypropylene
Rolling seal	EPDM
Plug	Reinforced Nylon / Polypropylene
O-ring	NBR / EPDM / Viton
Body	Reinforced Nylon
Domed nut	Stainless Steel 316
Stopper	Polypropylene
Spring	Stainless Steel 316 / Hastelloy
Float and rod	Polypropylene / Stainless Steel 316 or Titanium
O-ring	NBR / EPDM / Viton
Clamp assembly	Reinforced Nylon / Stainless Steel 316
Base	Reinforced Nylon
Tap	Stainless Steel 316
Flange (optional)	Reinforced Nylon



→ Catalog numbers examples

Description	Catalog number
D25 2" NPT NYLON3 150PSI NTW VITON	70561-016001
D25 2" NPT NYLON3 PN10 VITON, MINES	70561-016530
D25 4" MULTI STAND STST316 150PSI VITON,STST D40 DR "1.5	70561-017900

*Other configurations are available upon request

→ Flow charts

Air & Vacuum Flow Rate

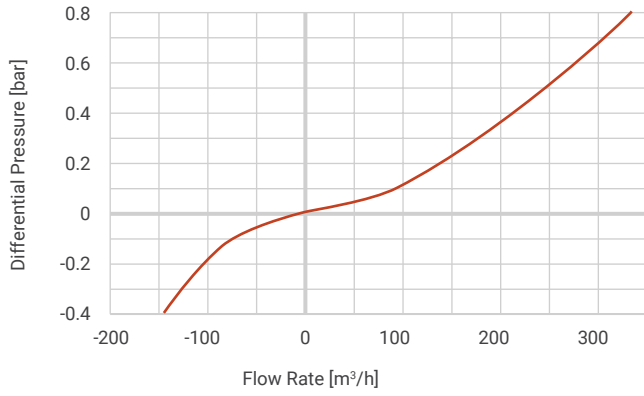

Automatic Air Release Flow Rate

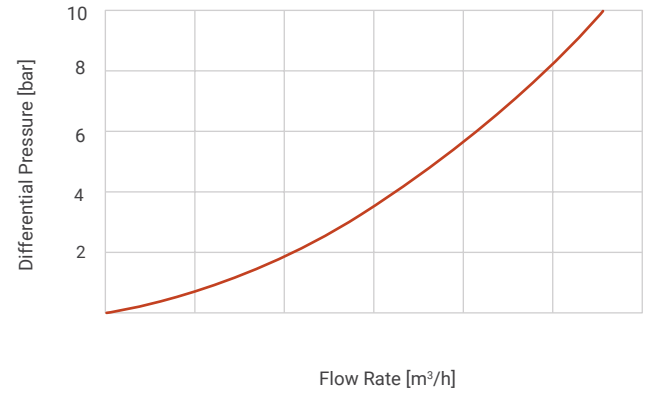

D-25 NS

Air & Vacuum Flow Rate

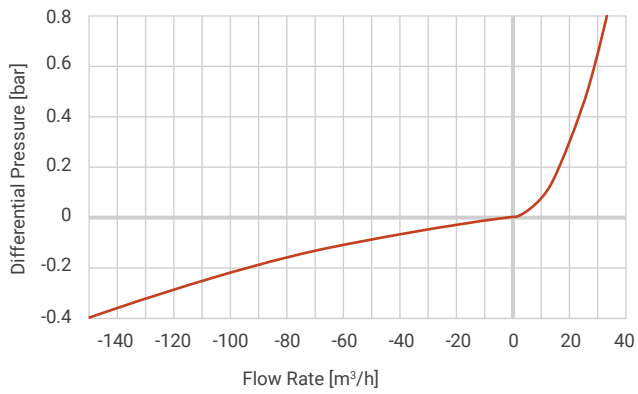

Air Discharge Flow Rate

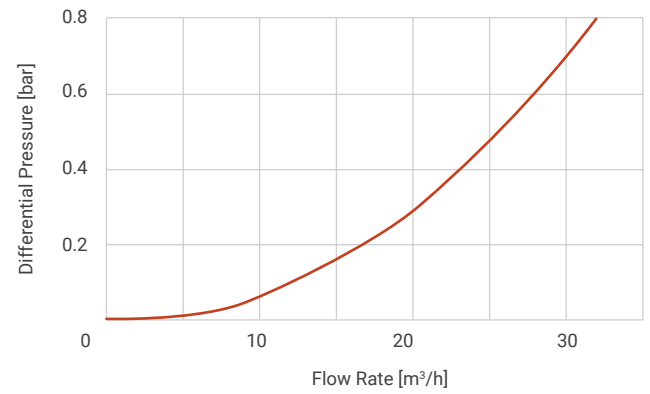

D26

A full-bore combination air valve. Installed on a non-clean water/mining conduction system, the air valve is designed to improve hydraulic operation by protecting the pipeline, increasing pipeline efficiency and reducing energy requirements. A continuous air gap in the valve body separates the water/solution from the sealing mechanism.



Superior design



Long lasting performance



Efficient installation

/ Benefits & Features

- **Superior design** Maximum air gap / minimum body length.
A continuous air gap separates the liquid from the sealing mechanism.
- **Long lasting performance** Free movement, turbulence will not unseal the sealing mechanism.
Residue matter falls back into the system pipeline.
- **Efficient installation** Flow enhancer, prevents spraying from valve outlet.
Non-corrosive and durable parts.

/ Specifications

- Size range: 2" - 8".
- Sealing pressure range:
2"; 0.05-10 bar or 0.10-16 bar.
3"; 0.05-10 bar or 0.10-16 bar or 0.20-2.5 bar.
4", 6", 8"; 0.10-16 bar.
- Testing pressure: 1.5 times maximum working pressure.
- Maximum working temperature: 60° C.
- Valve coating: Fusion-bonded epoxy coating in compliance with standard DIN 30677-2 (applied on Cast Steel and Cast Ductile Iron valves).
- Valve connection: Threaded male BSPT/NPT; Flanged ends to meet various requested standards.

→ Technical dimensions

Model	Dimensions (mm)		Air release	Weight (kg)		Orifice area (mm ²)	
	A	B	C	RN	SST	Auto	a/v
2" THR	258	547	2"BSP/NPSM F	8.1	13.2	8.6	1963
2" FL	258	554	2"BSP/NPSM F	8.5	16.1	8.6	1963
2" THR NS	330	547	2"BSP/NPSM M	8.3	13.6	8.6	1963
2" FL NS	330	554	2"BSP/NPSM M	8.7	16.5	8.6	1963
One-directional cover				Cast steel	SST		
3" THR	526	580	3"BSP/NPSM F	21.0	21.6	15.7	5024
3" FL	526	580	3"BSP/NPSM F	21.6	24.6	15.7	5024
3" THR NS	548	580	3"BSP/NPSM M	21.8	22.5	15.7	5024
3" FL NS	548	580	3"BSP/NPSM M	24.7	25.5	15.7	5024
Two-directional cover				Cast steel	SST		
3" THR	495	620	3"BSP/NPSM F	21.8	22.5	15.7	5024
3" FL	495	620	3"BSP/NPSM F	24.2	25.0	15.7	5024
3" THR NS	605	620	3"BSP/NPSM M	22.7	23.4	15.7	5024
3" FL NS	605	620	3"BSP/NPSM M	24.7	25.4	15.7	5024
Two-directional cover RN				RN			
3" THR	350	613	3"BSP/NPSM F	14.6	-	15.7	5024
3" FL	350	625	3"BSP/NPSM F	15.4	-	15.7	5024
3" THR NS	436	613	3"BSP/NPSM M	15.4	-	15.7	5024
3" FL NS	436	625	3"BSP/NPSM M	16.1	-	15.7	5024
				DI	SST		
4" FL	420	830	4" Flanged BSP/NPSM F	43.6	45	31.1	7854
4" FL NS	607	849	4" Flanged BSP/NPSM F	48.5	50	31.1	7854
Vertical cover				DI	SST		
6" FL	497	827	6" Flanged/Grooved	93.4	97.5	31.1	17671
8" FL	617	1081	8" Flanged/Grooved	148.8	156.5	31.1	31400
Horizontal cover				DI	SST		
6" FL	532	942	6" Flanged/Grooved	99.9	105.7	31.1	17671
8" FL	646	1242	8" Flanged/Grooved	158.4	163.9	31.1	31400

RN- Reinforced Nylon, SST- Stainless steel, DI- Ductile Iron, FL – Flanged, THR – Threaded
 NS- Non-slam discharge-throttling attachment, allows for free air intake, throttles air discharge.
 All product weights and dimensions are approximate, due to the differences in flange standards, materials and variable accessories.



→ Components raw materials

Part	Material
Orifice plug	Polypropylene
Cover	Stainless Steel 316 / Super Duplex
Bolt Assembly	Stainless Steel 316 / Reinforced Nylon
Non-slam component (optional)	Reinforced Nylon / Polypropylene / Stainless Steel
Disc arm	Stainless Steel 316 / Super Duplex
Air and vacuum disc	Reinforced Nylon / Polypropylene
Air and vacuum seal	EPDM / Viton
Air release seal and seat	EPDM / Viton
Seal cover	Reinforced Nylon / Polypropylene
"O"-Ring	NBR / EPDM / Viton
Spray Guard®	Polypropylene
Body	Reinforced Nylon / Stainless Steel 316 / Super Duplex
Domed nut	Stainless Steel 316 / Super Duplex
Stopper	Polypropylene
Spring	Stainless Steel 316 / Hastelloy
Float and Rod	Polypropylene / stainless steel 316 7 titanium
"O"-Ring	NBR / EPDM / Viton
Clamp Assembly	Stainless Steel 316 / Super Duplex
Base	Reinforced Nylon / Stainless Steel 316 / Super Duplex
Tap	Stainless Steel 316 / Super Duplex



→ Components raw materials

Part	Material
Flange seal (optional)	NBR
Grooved flange (optional)	Ductile Iron / Stainless Steel 316
Discharge	Ductile Iron / Stainless Steel 316
"O"-Ring	EPDM / Viton
Cover	Ductile Iron / Stainless Steel 316
Orifice Seat	Stainless Steel 316
Guide rod assembly	Stainless Steel 316 / Acetal
Air and vacuum disc	Reinforced Nylon / Reinforced Polypropylene
Air and vacuum seal	EPDM / Viton
Air release seal and seat	EPDM / Viton / Reinforced Nylon
Seal cover	Reinforced Nylon
Domed nut	Stainless Steel 316
Stopper	Stainless Steel 316
Spring	Stainless Steel 316
Float and Rod	Stainless Steel 316
"O"-Ring	EPDM / Viton
Body	Ductile Iron / Stainless Steel 316
Ball Valves	Stainless Steel 316



→ Flow charts

D-26 2"

Air & Vacuum Flow Rate

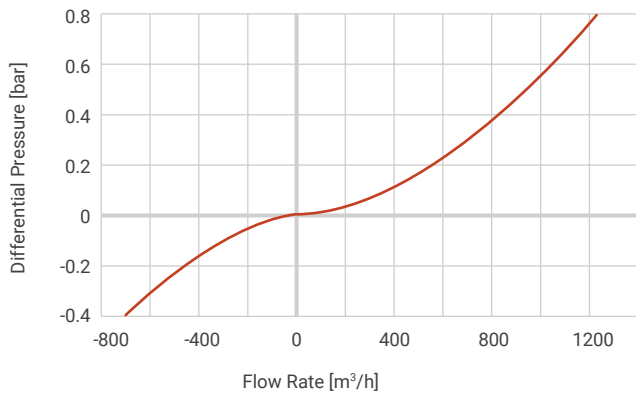

Automatic Air Release Flow Rate

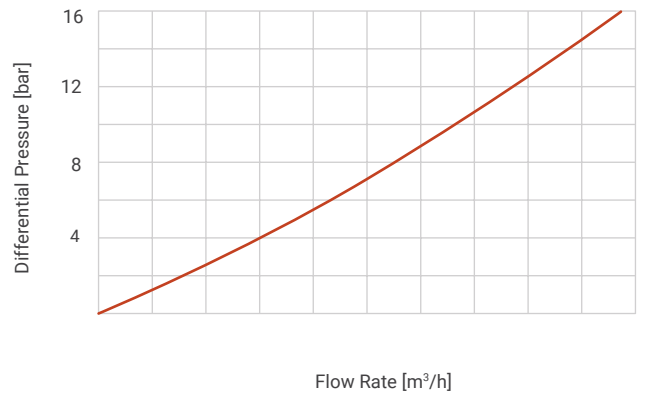

D-26 NS 2"

Adjustable NS Check Valve

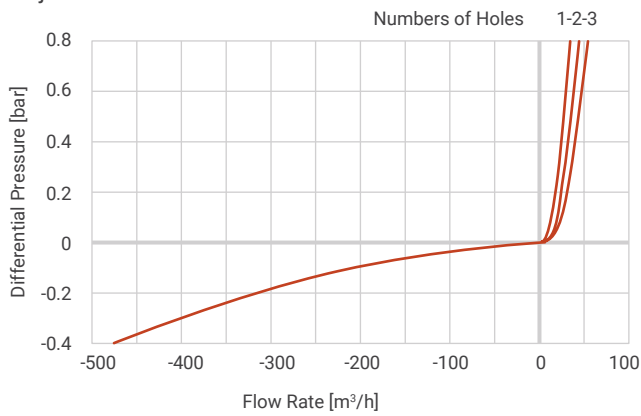

Adjustable NS Check Valve

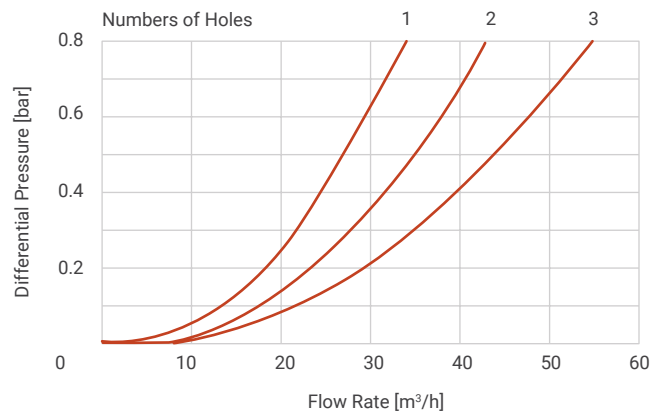

→ Flow charts

D-26 3"

Air & Vacuum Flow Rate

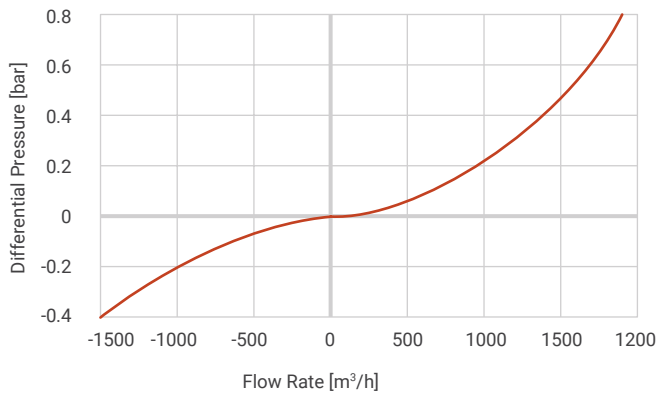

Automatic Air Release Flow Rate

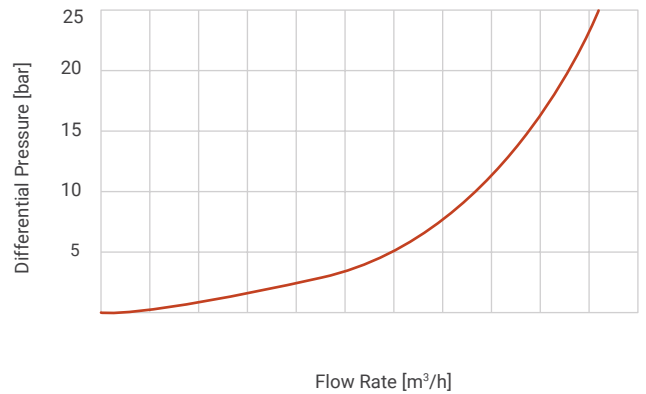

D-26 NS 3"

Adjustable NS Check Valve

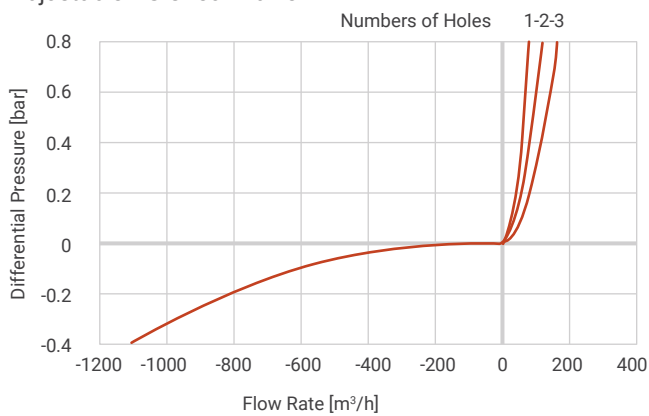

Adjustable NS Check Valve

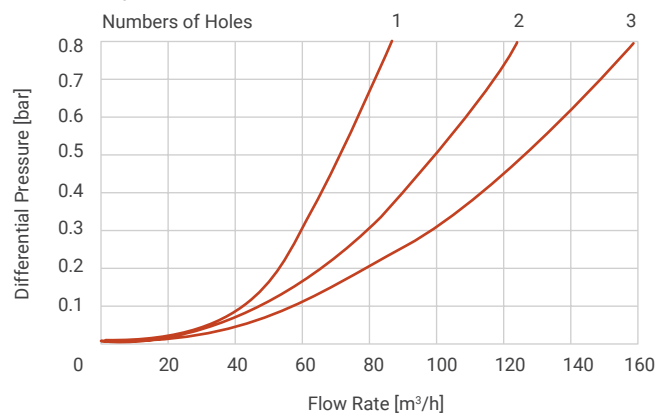

→ Flow charts

D-26 4"

Air & Vacuum Flow Rate

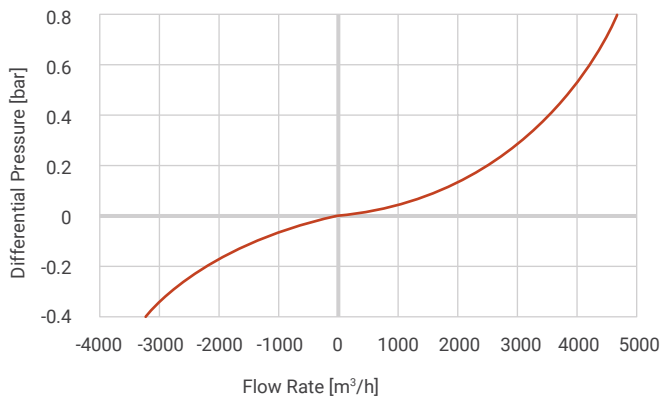

Automatic Air Release Flow Rate

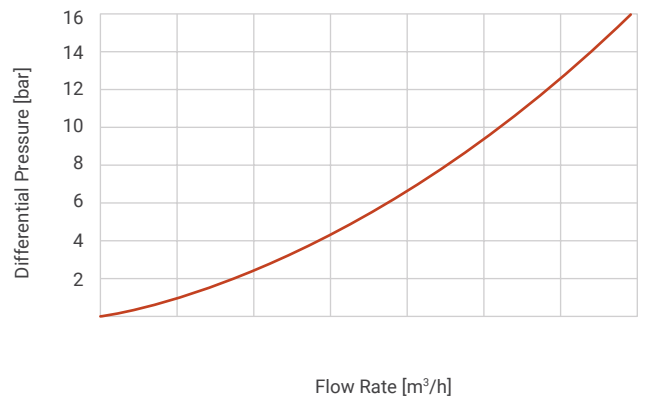

D-26 NS 4"

Adjustable NS Check Valve

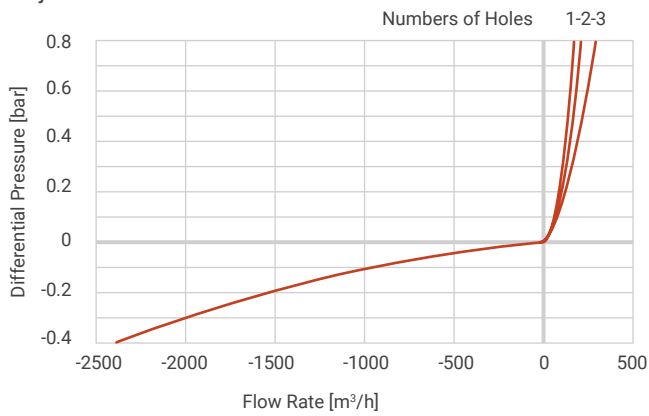

Adjustable NS Check Valve

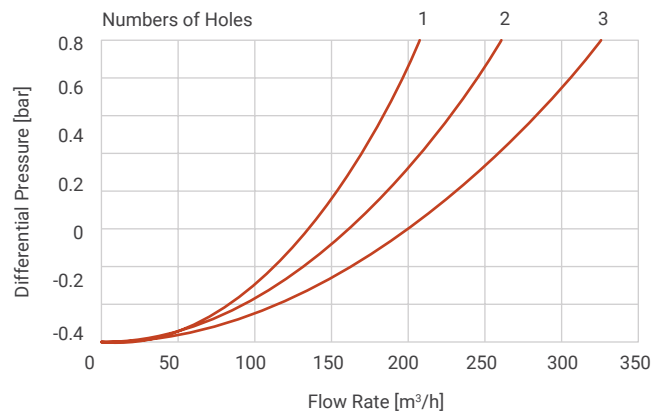

→ Flow charts

D-26 6"

Air & Vacuum Flow Rate

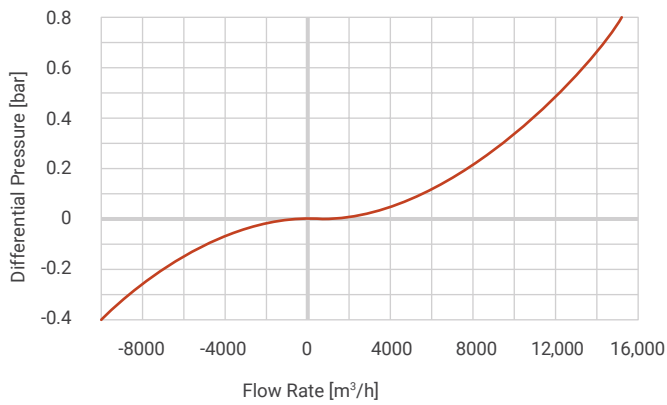

Automatic Air Release Flow Rate

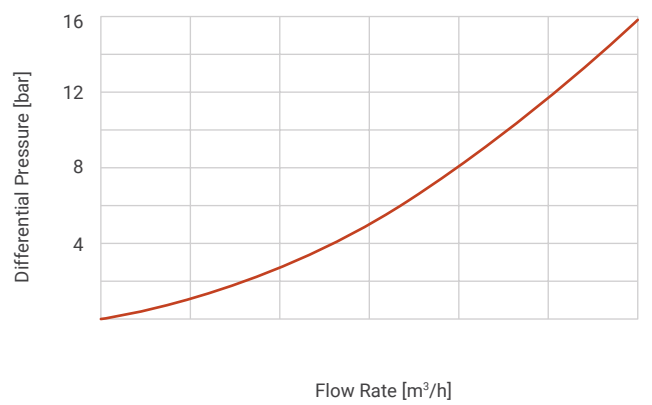

D-26 NS 6"

Air & Vacuum Flow Rate

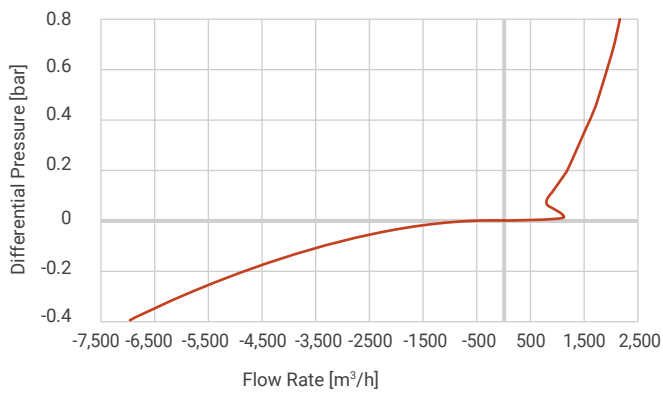

Air Discharge Switching Region

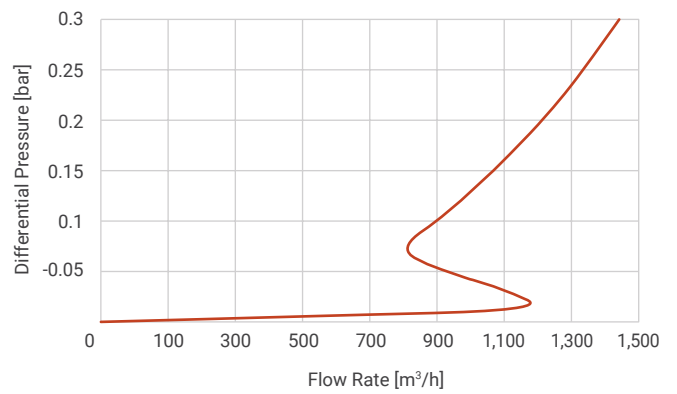

→ Flow charts

D-26 8"

Air & Vacuum Flow Rate

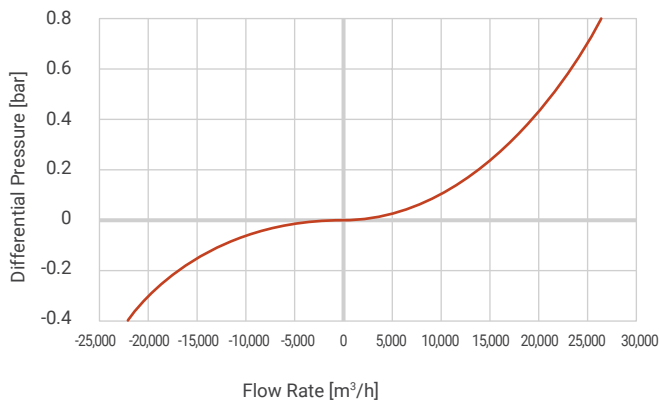

Automatic Air Release Flow Rate

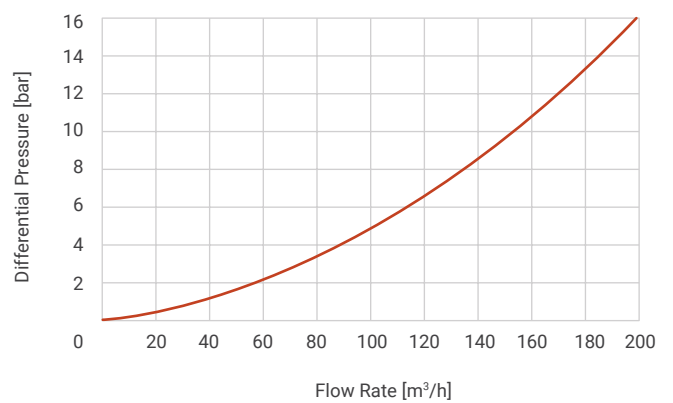

D-26 NS 8"

Air & Vacuum Flow Rate

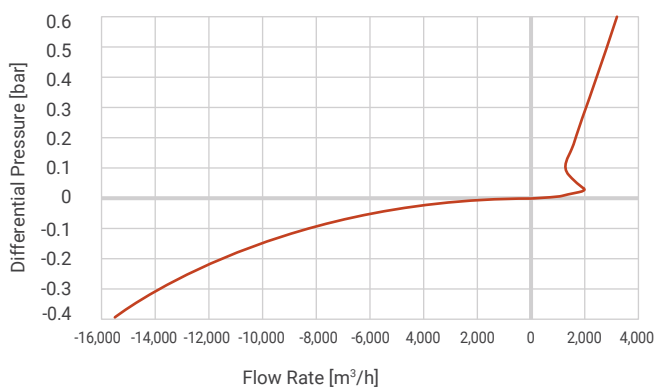

Air Discharge Switching Region

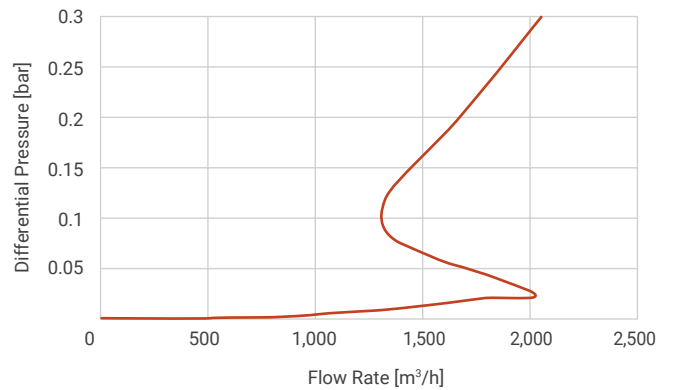

→ Catalog numbers examples

Description	Catalog number
D26 2" NPT STST316 250PSI USA PPV	70561-000021
D26 3" MULTI STAND STST316 PN16 COVER NPSM STST FLOAT & FL	70561-016197
D26 3" MULTI STAND STST316 250PSI USA COVER NPSM, STST FLOAT	70561-000010
D26 6" ASA150 STST316 PN16 MINES	70561-004960
D26I 3" MULTI STAND STST316 PN16 NTW COVER NPSM STST FLOAT &	70561-000017
D26NS 3" MULTI STAND STST316 PN16 COVER NPSM STST FLOAT &	70561-018030
D26NS 3" MULTI STAND STST316 PN16 COVER NPSM STST FLOAT &	70561-018345
D26V 3" MULTI STAND STST316 PN16 COVER NPSM STST FLOAT & F	70561-000005

*Other configurations are available upon request

Water Meters



→ Technical dimensions

Diameter	mm	40 Thrd.	50 Thrd.	50	65	80	100	150	200	250	300
	inch	1½ Thrd.	2 Thrd.	2	2½	3	4	6	8	10	12
L - Length without couplings (mm)		300	300	200	200	225	250	300	350	449	499
w - Width (mm)		113	113	165	185	200	220	285	340	406	489
H - Height (mm)		155	155	194	210	210	223	282	332	383	456
h - Height (mm)		35	35	40	90	90	103	140	165	203	245
Weight (kg) - Cast iron body			8	9	11.5	13	15	32	45	68	96
Weight (kg) - Polymer body		1.4	1.45								
Weight (kg) - Stainless Steel body		4	4	6		7	9.5	16			

→ Head loss

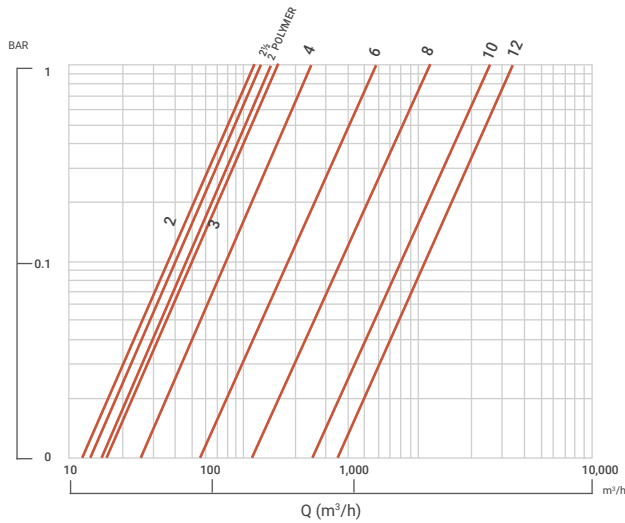

Flanged

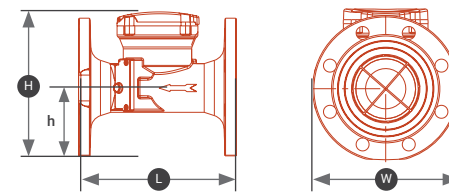

Threaded

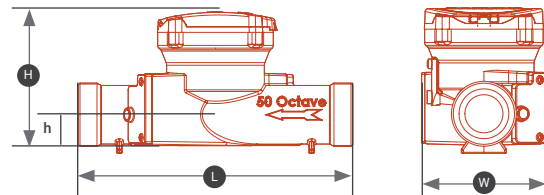

→ Catalog numbers

Material	Diameter	Connection type	Catalog number
Cast Iron	2"	ISO	70240-014020
		BSTD	70240-014000
		ANSI	70240-013975
	3"	ISO	70240-014120
		BSTD	70240-014100
		ANSI	70240-014155
	4"	ISO	70240-014250
		BSTD	70240-014200
		ANSI	70240-021452
	6"	ISO	70240-014300
		BSTD	70240-014350
		ANSI	70240-021453
	8"	ISO	70240-014400
		BSTD	70240-014450
		ANSI	70240-021454
	10"	ISO	70240-014490
		BSTD	70240-014500
		ANSI	70240-021455
12"	ISO	70240-014550	
	BSTD	70240-014560	
	ANSI	70261-000485	

Material	Diameter	Connection type	Catalog number
Plastic	1½"	BSP	70240-013910
	2"		70240-013982
Stainless Steel	2"	BSP	70240-000205
		ISO	70240-000206
		BSTD	70240-000200
	3"	ANSI	70240-021490
		ISO	70240-000207
		BSTD	70240-000201
	4"	ANSI	70240-021491
		ISO	70240-000208
		BSTD	70240-000202
	6"	ANSI	70240-021492
		ISO	70240-000209
		BSTD	70240-000203
		ANSI	70240-021493

→ Module type

Module type	Catalog number
Solid state relay	70220-060410
Open drain	70220-060400
4-20mA	70220-011565

Ultraf™

An ultrasonic water meter, a hydraulic valve and a smart system for water measurement, pressure control and pressure management.

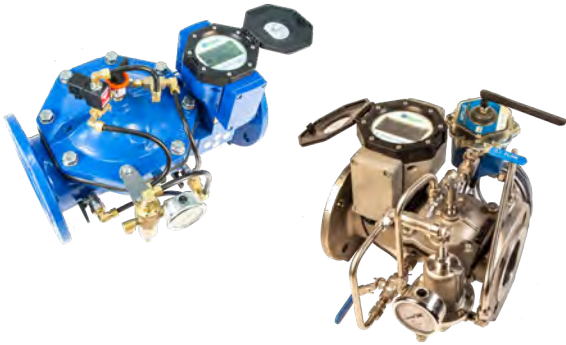

Innovative



Superb
quality



User
friendly

/ Benefits & Features

- **Innovative** Single compact unit, space-saving design. Pressure control. Battery operated with extended battery life.
- **Reliable** No moving parts. Minimal maintenance.
High-level protection, according to IP68. Low head loss.
- **Smooth operation** Simple to install and operate. Bluetooth App for field programming. Optional cards (digital and analog output).

→ Technical dimensions

Diameter	mm	50	80	100	150	200
	inch	2	3	4	5	8
Length (mm)		260	300	350	500	600
Height (mm)		270	300	320	380	420
Width (mm)		190	223	240	320	370
Weight (kg)		10	15	23	44	67

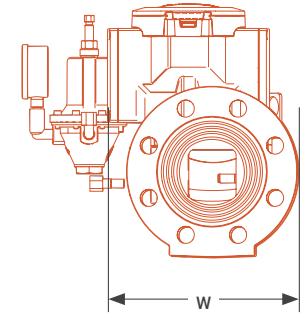
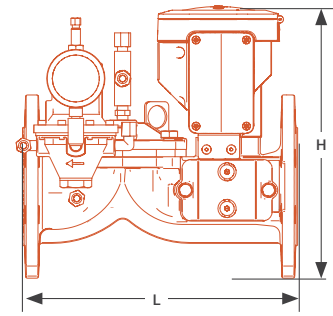

→ Hydraulic performance

Flow rate (m ³ /h)	DN 40-1½"	DN 50-2"	DN 80-3"	DN 100-4"	DN 150-6"	DN 200-8"
Q1 Minimum flow rate	0.16	0.25	0.63	0.8	2	3.2
Q2 Transitional flow rate	0.256	0.4	1	1.28	3.2	4
Q3 Permanent flow rate	16	25	63	100	250	400
Q4 Overload flow rate	20	31.25	78.75	125	312.5	500
Max. flow for short period (m ³ /h)	30	50	125	200	400	600

→ Head loss

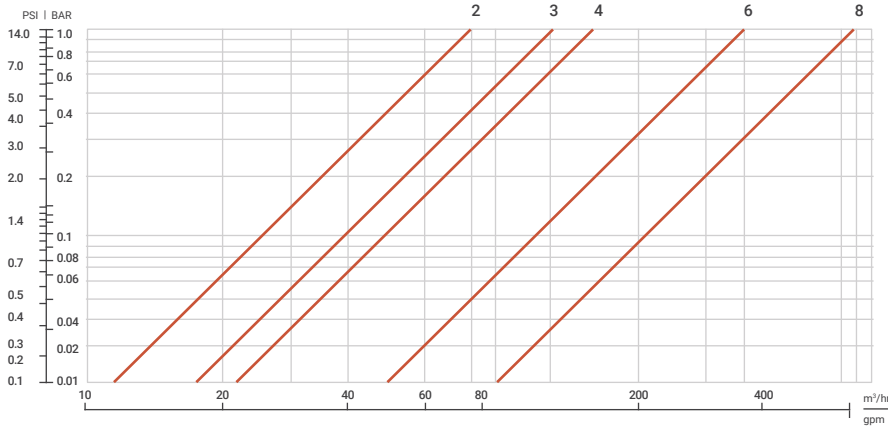

→ Catalog numbers

Product description	2"	3"	4"	6"	8"
ULTRAF-630T PRV MP BSP T W/PULSE					
ULTRAF-630T PRV MP BSTD T W/PULSE		75800-000061	75800-000062		
ULTRAF-6R-IC PRV 3W W/CON.PUL BSP	75800-000063				
ULTRAF-6R-IC PRV 3W W/CON.PUL BSTD		75800-000064			
ULTRAF-IC W/CONTROLLER BSP	75800-000065				
ULTRAF-IC W/CONTROLLER BSTD		75800-000066	75800-000067	75800-000068	75800-000069
ULTRAF-01 TYPE CONTROL ON/OFF W/PULSE 2"	75800-004315	75800-004320	75800-004325	75800-004330	75800-004335
ULTRAF-01 TYPE CONT.ON/OFF FL. ISO16		75800-000047			
HYDROMETER ULTRAF-6P-0T+PRV ISO PN16		75800-003955			
HYDROMETER PRE.RED ULTRAF- BS			75800-004310		

*Missing catalog numbers available upon request

Filters



Manual Disc Filters

Manual disc filters, Leader and Super Leader, offer a large filtration area with high efficiency which leads to better solution distribution uniformity with much less maintenance. Help protect the leaching system from activated carbon, increasing dripline longevity and leaching uniformity.



/ Benefits & Features

- **Versatile** Suitable for all commonly used fertilizers and acids, as well as sea and brackish water, high and low pH 2-13.
- **Smooth operation** Easy to open, clean and close.
- **Durable construction** Polypropylene housing offers excellent chemical resistance.

/ Specifications

- Inlet/outlet diameter – 90 mm / 3", 110 mm / 4", 160 mm / 6".
- Maximum pressure – 10 bar / 145 psi.
- Maximum flow rate – 60 m³/h / 264 gpm.
- Maximum temperature – 60°C / 140°F.
- pH – 2-13 (at 20°C) / 2-13 (at 68°F).

→ **Technical dimensions**

Diameter		3" Leader twin	3" Super angle	4" Super angle	4" Super leader	6" Super leader
width	W	226 / 8 ^{7/8"}	700 / 27 ^{9/16"}		330 / 13"	
Length	L	742 / 29 ^{7/32"}	410 / 15 ^{3/4"}		1190 / 47"	
Distance between connections	A	320 / 12 ^{19/32"}	-	-	445 / 17.5"	415 / 16.3"
Weight (victaulic, threaded)		6.3 kg / 14 lbs	10 kg / 22 lbs	10.6 kg / 23.32 lbs	22 kg / 48.4 lbs	26 kg / 57.2 lbs
Weight (flanged)		10 kg / 22 lbs	11.47 kg / 25.28 lbs	14.1 kg / 31.02 lbs	24 kg / 52.8 lbs	26 kg / 57.2 lbs

3" & 4" Super angle filter

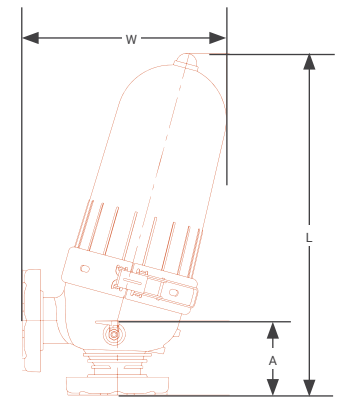

→ **Hydraulic performance**

Diameter		3" Leader twin	3" Super angle	4" Super angle	4" Super leader	6" Super leader
Max. pressure		10 bar / 145 psi				
Max. flow rate			60 m ³ /h / 246 gpm	90 m ³ /h / 396 gpm	100 m ³ /h / 440 gpm	160 m ³ /h / 704 gpm
Filtration area		1900 cm ² / 294.5 in. ²	1852 cm ² / 287 in. ²		3704 cm ² / 574 in. ²	
Filtration volume		2450 cm ³ / 174 in. ³	1744 cm ³ / 108 in. ³		3548 cm ³ / 216 in. ³	

3" & 4" & 6" leader twin / super leader filters

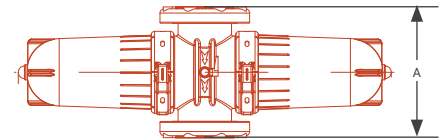
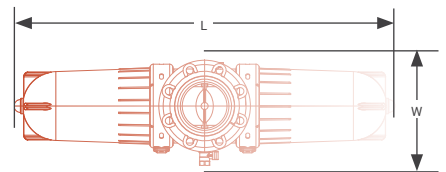

→ **Head loss**

3" Super angle filter

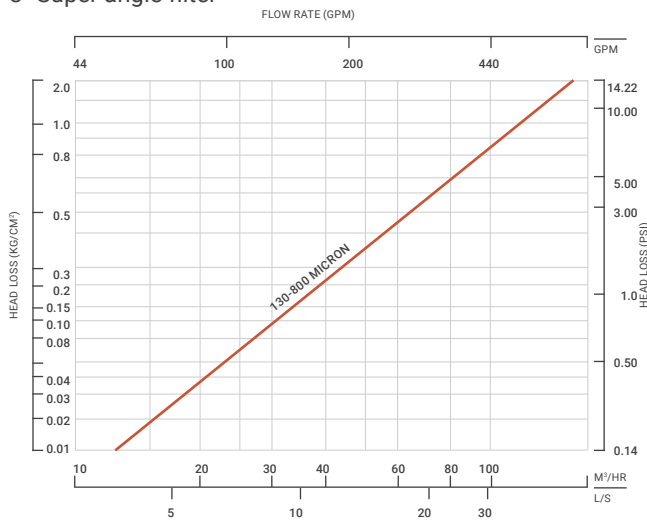

3" Leader twin

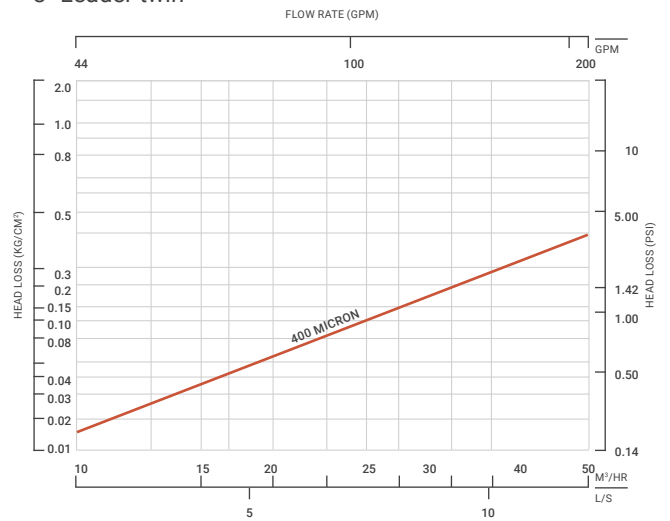

4" Super angle filter

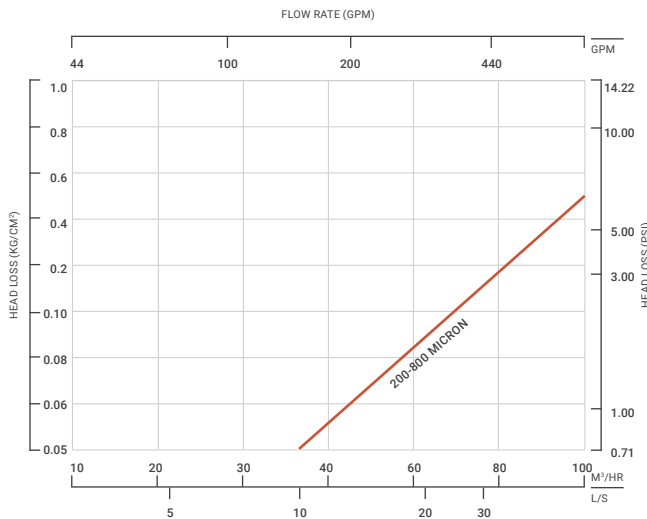

4", 6" Super Leader filter

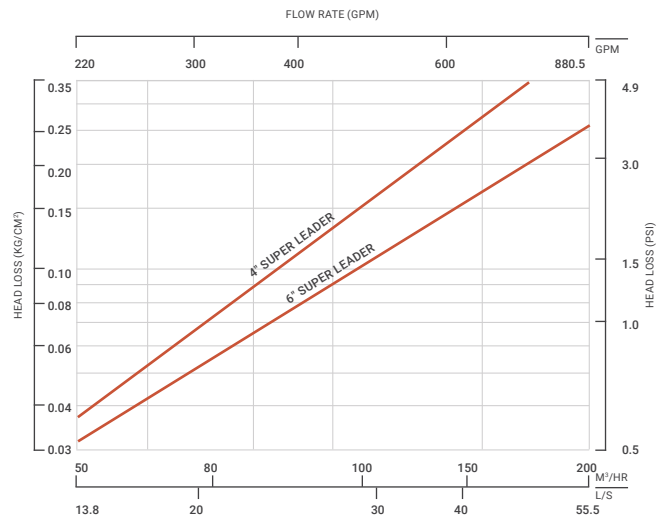

→ Components raw materials

3" Leader twin

#	Part name	Material
1	Body & cover	pp
2	Clamp	-
3	Spine	pp
4	Discs	pp
5	Seals & o-rings	EPDM
6	Ball valve	BRASS
7	Loose flange	R.PA
8	Flange cone	POM
9	Flange seal	EPDM

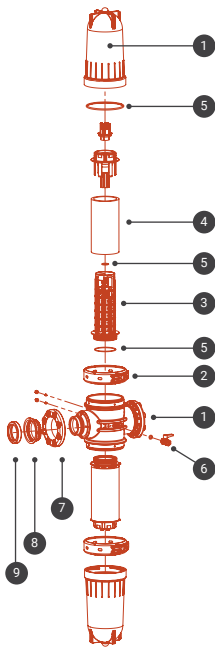

3" & 4" Super angle

#	Part name	Material
1	Body & cover	pp
2	Clamp	sst
3	Spine	r.pp
4	Discs	pp
5	Seals & o-rings	EPDM
6	Ball valve	BRASS
7	Loose flange	R.PA
8	Flange cone	POM
9	Flange seal	EPDM

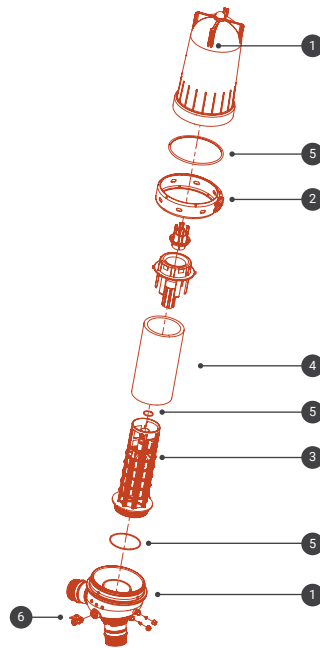

4" & 6" Super Leader

#	Part name	Material
1	Body & cover	pp
2	Clamp	sst
3	Spine	r.pp
4	Discs	pp
5	Seals & o-rings	EPDM
6	Ball valve	BRASS
7	Loose flange	R.PA
8	Flange cone	POM
9	Flange seal	EPDM

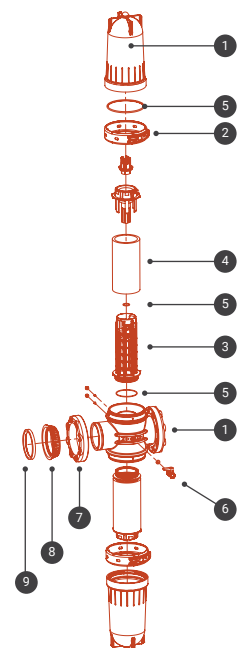

→ Nomenclature description

Short name	Material
r.PP	Reinforced Polypropylene
R.PA	Reinforced Polyamide
SST	Stainless Steel
PP	Polypropylen
POM	Polyacetal
EPDM	EPDM
Loose Flange	R.PA
Flange Cone	POM
Flange Seal	EPDM

→ Catalog numbers

The type of filter and his catalog number will be determined according to the specific conditions in each application. For a correct configuration of a required filter please contact us at Mining@netafim.orbia.com or contact your Netafim™ local representative.

ScreenGuard™

Netafim™ manual, polymer screen filters offer high quality small filters with large filtration area and high efficiency for ease of installation and less maintenance.



Wide filtration
area



Superb
quality



High
durability

/ Benefits & Features

- **Wide filtration area** Results in lower labor cost due to longer cleaning intervals even in harsh water conditions
- **Filter housing and cover** Molded from high quality durable materials for mechanical strength and non-corrosiveness
- **Stainless steel 316L screen** Long lasting filter screen cylinder

/ Specifications

- A "Y" shape model, with multiple filtration area options covering a wide range of flow rates.
- Two options in BSP and NPT threads.
- Different micron rating screens.
- Maximum operating pressure: 8 bar (116 psi).

→ Logistic data

Model	Box					Pallet (including the pallet)				
	Qty. in box (units)	Length (mm)	Height (mm)	Width (mm)	Gross weight per box (kg)	Qty. of boxes in pallet (units)	Length (mm)	Height (mm)	Width (mm)	Gross weight per pallet (kg)
¾"	25	740	240	345	7.2	42	1500	1900	1150	326
1"					7.6					342
1" Long	11.3				498					
1.5"	11.9				522					
1.5" Long	6.9				312					
2"	7.0				318					

→ Technical information

Description	Filtration area (cm ²)	Available connection types	Maximum recommended flow rate (m ³ /h)	Max. working pressure (bar)
¾"	165	BSP / NPT	3.5	8
1"			4.5	
1" Long	6.0			
1.5"	7.0			
1.5" Long	12.5			
2"	515		16.0	

→ Components raw materials

Part	Material
Body	PP
Cover	PP
Screen	ST 316
Seal	NBR

→ Head loss

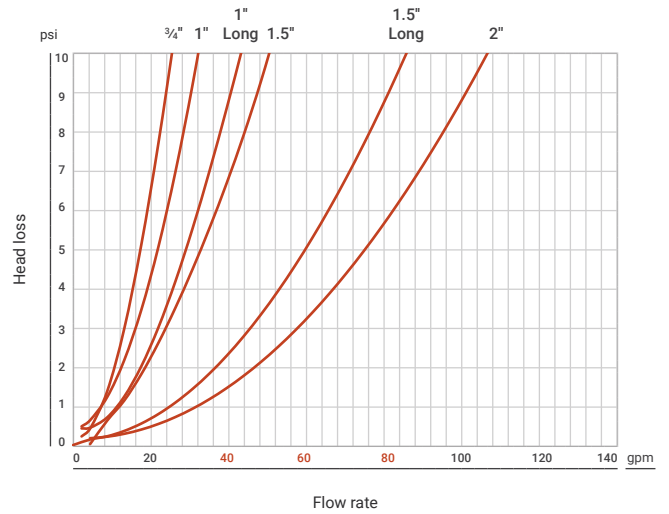
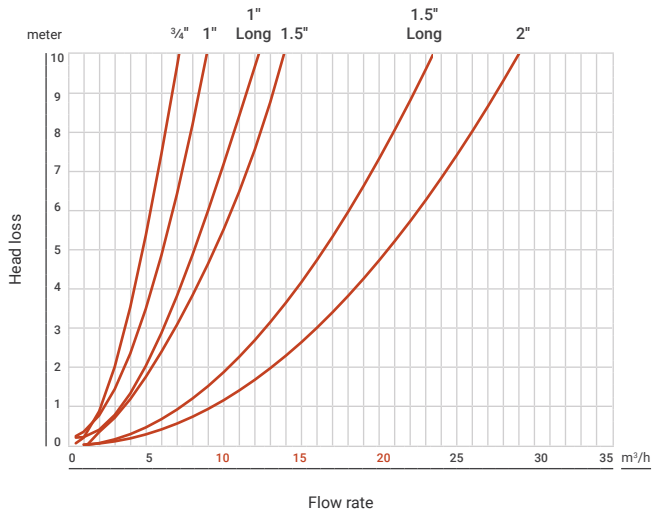

→ Catalog numbers

The type of filter and his catalog number will be determined according to the specific conditions in each application. For a correct configuration of a required filter please contact us at Mining@netafim.orbia.com or contact your Netafim™ local representative.

ScreenGuard™

Netafim™ manual, polymer screen filters offer the largest filtration area in the industry. The result - better filtration efficiency, excellent irrigation uniformity and much less maintenance.

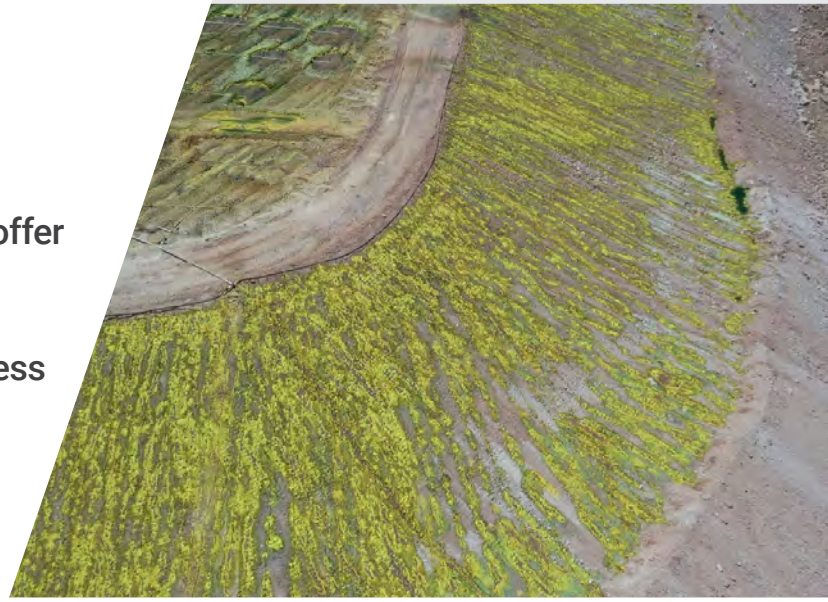

Wide filtration area



Very high efficiency



High durability

/ Benefits & Features

- **Wide filtration area** The extremely large filtration area results in lower labor cost due to longer cleaning intervals even in harsh water conditions.
- **Extra protective layer** Filter screen cylinder molded with stainless-steel 316L screen with special weave incorporated allowing additional protection and easy maintenance.
- **Plastic filter housing & cover** Molded from high quality engineered plastic for mechanical strength, durability, and non-corrosiveness.
- **Multiple configurations** Fits perfectly with any irrigation system thanks to different configuration and connection types.
- **Semi-automatic feature** Can be assembled into the filter.

/ Specifications

- Multiple filtration area options.
- Variety of models covering a wide range of flow rates, ensures a perfect fit for different water quality and protection requirements.
- Different micron rating screens.
- Maximum operating pressure: 10 bar (145 psi).

→ Logistic data

Model	Connection type	Box						Pallet (including the pallet)				
		Qty. in box	Length (mm)	Height (mm)	Width (mm)	Gross weight p/box (kg)	Qty. of boxes in pallet	Length (mm)	Height (mm)	Width (mm)	Gross weight p/pallet (kg)	
Tee Filter	2" Mini	BSP / NPT	1	530	280	370	7.0	42	1110	2100	1150	310.5
	2" Regular	BSP / NPT	1	650	280	370	7.8	42	1300	2100	1150	344.6
	2" Jumbo	BSP / NPT	1	790	280	370	8.8	42	1650	2100	1150	391.6
	3" Regular	BSP / NPT / UNF / VIC	1	650	280	370	7.8 (NPT,BSP) 9.4 (UNF)	42	1300	2100	1150	344.6 (NPT,BSP) 411.8 (UNF)
	3" Jumbo	BSP / NPT / UNF / VIC	1	790	280	370	8.8 (NPT,BSP) 10.2 (UNF)	42	1650	2100	1150	391.6 (NPT,BSP) 450.4 (UNF)
Twin Filter	3" Reg. Double	BSP / NPT / UNF / VIC	1	990	280	380	12.4 (NPT, BSP) 14.0 (UNF)	21	1000	2100	1150	276.6 (NPT, BSP) 310.2 (UNF)
	3" Jumbo double	BSP / NPT / UNF / VIC	1	1230	280	380	14.4 (NPT, BSP) 16.0 (UNF)	21	1250	2100	1150	319.2 (NPT, BSP) 352.8 (UNF)
	4" Reg. double	VIC / UNF	1	990	280	380	14.2	21	1000	2100	1150	314.4
	4" Jumbo double	VIC / UNF	1	1230	280	380	16.4	21	1250	2100	1150	361.2
	6" Jumbo double	VIC / UNF	1	2200	550	550	26.0	1	2200	710	570	54.0

→ Technical information

Description	Filtration area (cm ²)	Available connection types	Maximum recommended flow rate (m ³ /h)	Max. working pressure (bar)
Tee filter	2" Mini	BSP / NPT	15	10
	2" Regular	BSP / NPT	20	10
	2" Jumbo	BSP / NPT	25	10
	3" Regular	BSP / NPT / UNF	25	10
	3" Jumbo	BSP / NPT / UNF	30	10
Twin filter	3" Double	BSP / NPT / UNF	45	10
	3" Jumbo double	BSP / NPT / UNF	50	10
	4" Double	UNF / VIC	60	10
	4" Jumbo double	UNF / VIC	75	10
	6" Jumbo double	UNF / VIC	120	10

→ Components raw materials

Part	Material
Body	GRP
Seal	Nbr
Screen	Sst
Drain valve	Pvc

→ Head loss

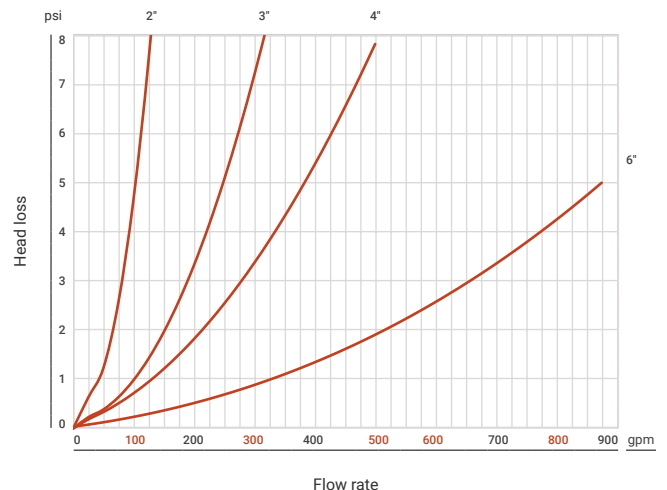
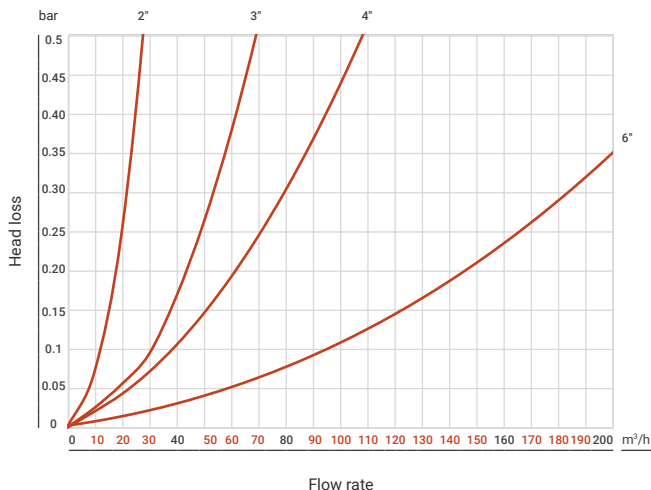

→ Catalog numbers

The type of filter and his catalog number will be determined according to the specific conditions in each application. For a correct configuration of a required filter please contact us at Mining@netafim.orbia.com or contact your Netafim™ local representative.

ScreenGuard™

Netafim™ semi-automatic polymer filters that provide the industry's best filtration efficiency and allow super-easy cleaning of the screen without opening the filter or shutting of water.

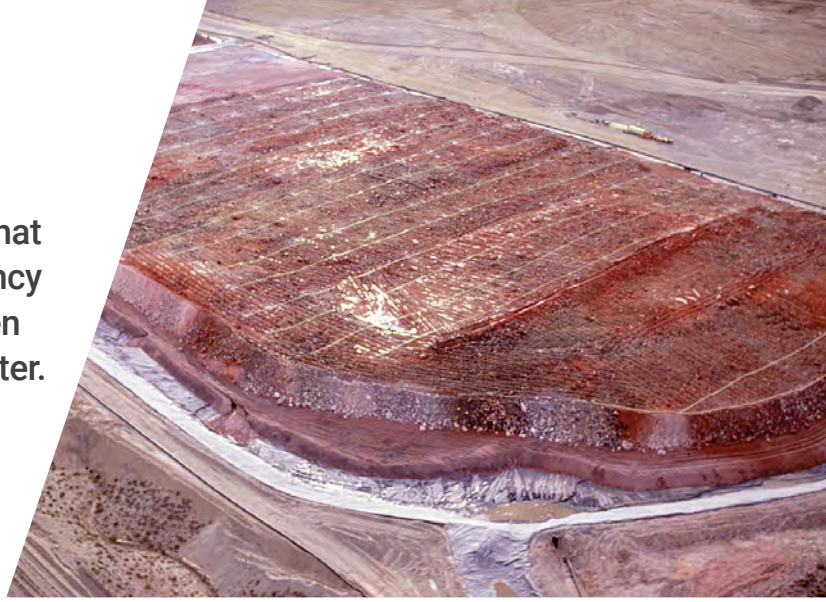

Wide filtration area



Lower operational cost



High durability

/ Benefits & Features

- **Wide filtration area** Results in lower labor cost due to longer cleaning intervals even in harsh water conditions.
- **Low maintenance**
 - Simple to clean, the screen can be perfectly cleaned with a single turn of the handle without disassembling the filters and without disrupting the irrigation process.
 - Ease of installation and maintenance.
- **Sturdy and durable** Molded from high quality engineered plastic for mechanical strength, durability and non-corrosiveness.
- **Extra protective** Filter screen cylinder molded with stainless-steel 316L is incorporated with a special weave, providing an extra protective layer to the irrigation system, and easy maintenance.

/ Specifications

- Covers a wide range of flow rates, ensures a perfect fit for different water quality and protection requirements.
- Multiple configurations and connection types and different micron rating screens enable to fit with any irrigation system.
- Maximum operating pressure: 10 bar (145 psi)

→ Logistic data

Model	Connection type	Box						Pallet (including the pallet)				
		Qty. in box	Length (mm)	Height (mm)	Width (mm)	Gross weight p/box (kg)	Qty. of boxes in pallet	Length (mm)	Height (mm)	width (mm)	Gross weight p/pallet (kg)	
Tee filter	2" Regular	BSP / NPT	1	790	280	370	9.2	42	1650	2100	1150	408.4
	2" Jumbo	BSP / NPT	1	910	280	370	10.2	28	1300	2100	1150	302.6
	3" Regular	BSP / NPT / UNF	1	790	280	370	9.4 (NPT, BSP) 10.6 (UNF)	42	1650	2100	1150	416.8 (NPT, BSP) 467.2 (UNF)
	3" Jumbo	BSP / NPT / UNF	1	910	280	370	10.4 (NPT, BSP) 11.8 (UNF)	28	1300	2100	1150	308.2 (NPT, BSP) 347.4 (UNF)
Twin filter	3" Double	BSP / NPT / UNF	1	1390	280	380	16.4 (NPT, BSP) 17.8 (UNF)	21	1450	2100	1150	364.4 (NPT, BSP) 393.8 (UNF)
	3" Jumbo double	BSP / NPT / UNF	1	1630	280	380	18.6 (NPT, BSP) 20.0 (UNF)	21	1650	2100	1150	412.6 (NPT, BSP) 442.0 (UNF)
	4" Double	VIC / UNF	1	1390	280	380	18.2	21	1450	2100	1150	402.2
	4" Jumbo double	VIC / UNF	1	1630	280	380	20.4	21	1650	2100	1150	450.4
	6" Jumbo double	VIC / UNF	1	2200	550	550	29.6	1	2200	710	570	57.6

→ Technical information

Description	Filtration area (cm ²)	Available connection types	Maximum recommended flow rate (m ³ /h)	Min. pressure during the backflush (bar)	Max. working pressure (bar)
Tee filter	2" Regular	BSP / NPT	20	2	10
	2" Jumbo	BSP / NPT	25	2	10
	3" Regular	BSP / NPT / UNF	25	2	10
	3" Jumbo	BSP / NPT / UNF	30	2	10
Twin filter	3" Double	BSP / NPT / UNF	45	2	10
	3" Jumbo double	BSP / NPT / UNF	50	2	10
	4" Double	UNF / VIC	60	2	10
	4" Jumbo double	UNF / VIC	75	2	10
6" Jumbo double	UNF / VIC	120	2	10	

→ Components raw materials

Part	Material
Body	Grp
Seal	Nbr
Screen	Sst
Drain valve	Pvc

→ Head loss

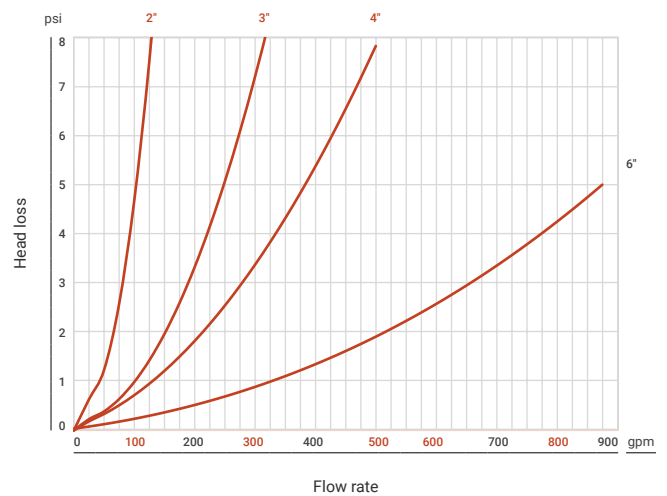
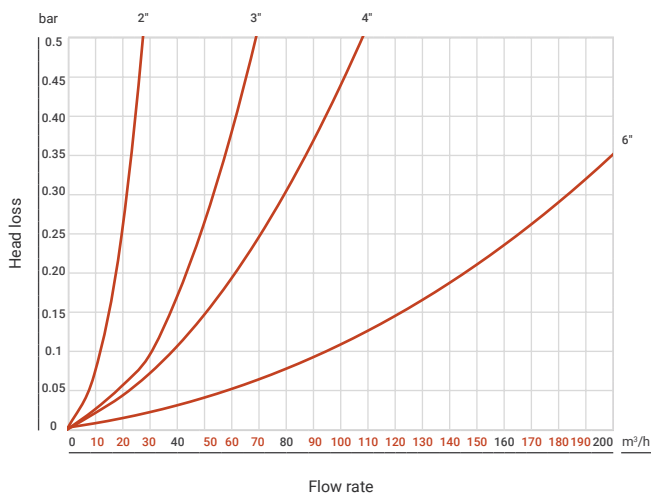

→ Catalog numbers

The type of filter and his catalog number will be determined according to the specific conditions in each application. For a correct configuration of a required filter please contact us at Mining@netafim.orbia.com or contact your Netafim™ local representative.

ScreenGuard™

Netafim™ manual in line metal screen filters filters, straight model, offer high corrosion and UV protection with large filtration area which result to better filtration efficiency, excellent irrigation uniformity and less maintenance.



Wide filtration area



High durability



Extremely versatile

/ Benefits & Features

- **Wide filtration area** Results in lower labor cost due to longer cleaning intervals even in harsh water conditions.
- **High corrosion and UV resistance** The filter housing is coated with dual layers for better UV and corrosion protection.
- **Versatile** Different micron rating screens suit a variety of applications.

/ Specifications

- Filter screen cylinder molded with stainless-steel 316L screen.
- Multiple filtration area options covering a wide range of flow rates, ensures a perfect fit for different water quality and protection requirements.
- Highly reliable and durable operation over time with maximum operating pressure of 10 bar (145 psi).

→ **Technical dimensions**

Connection diameter	A (mm)	B (mm)	C (mm)	D (mm)*	E (mm)*
1 1/2"	420	396	535	260	397
2"	420	373	510	260	397
3"	600	627	1,037	350	560
4"	800	856	1,483	460	796
6"	900	872	1,471	550	889
8"	1,000	1,195	2,112	715	1,243

* Minimum distance to draw screen

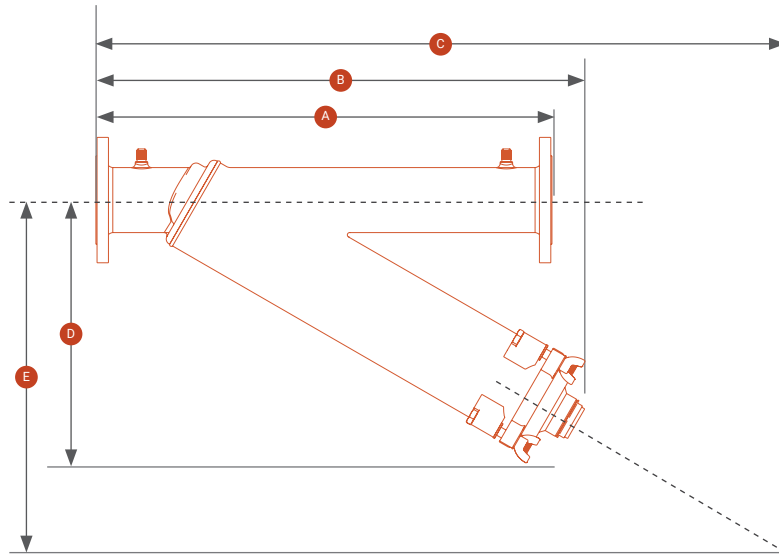

→ **Technical information**

Model	Filtration area (cm ²)	Available connection types	Maximum recommended flow rate (m ³ /h)	Drain valve diameters	Max. working pressure (bar)
1 1/2"	850	BSP / NPT	15	2"	10
2"	850	BSP / NPT / VIC	25	2"	10
3"	1700	BSP / NPT / VIC / ANSI / ISO / BSTD	50	2"	10
4"	2550	VIC / ANSI / ISO / BSTD	80	2"	10
6"	4000	VIC / ANSI / ISO / BSTD	160	2"	10
8"	6350	VIC / ANSI / ISO10 / VIC16 / BSTD	250	2"	10

→ **Head loss**

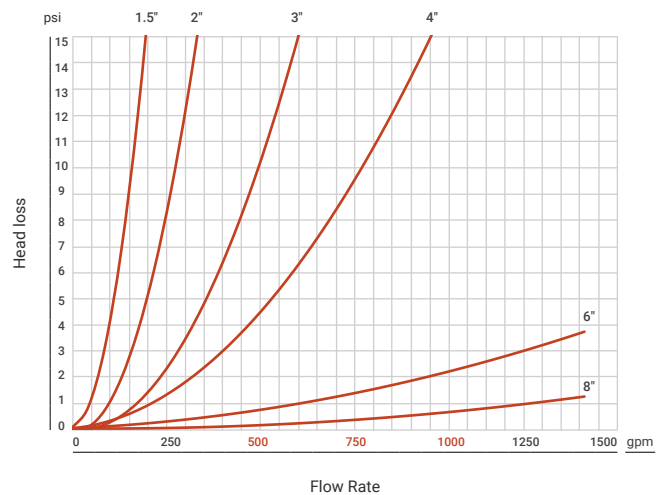
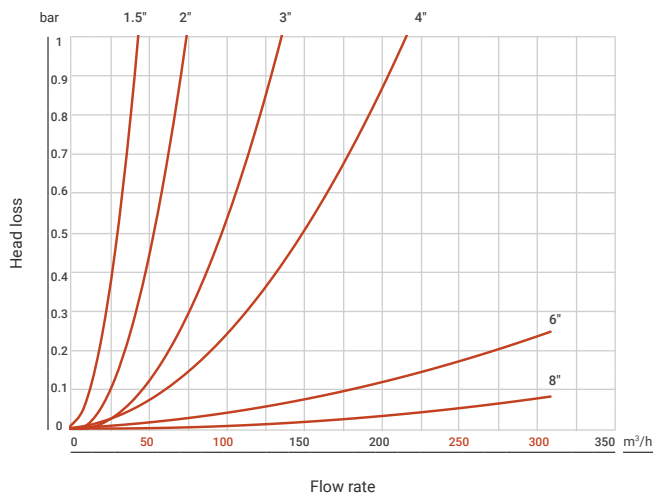

→ **Catalog numbers**

The type of filter and his catalog number will be determined according to the specific conditions in each application. For a correct configuration of a required filter please contact us at Mining@netafim.orbia.com or contact your Netafim™ local representative.

→ **Logistic data**

Model	Qty. in box	Box				Pallet (including the pallet)				
		Length (mm)	Width (mm)	Height (mm)	Gross weight p/box (kg)	Qty. of boxes in pallet	Length (mm)	Width (mm)	Height (mm)	Gross weight p/pallet (kg)
1½"	1	500	500	220	10	30	1500	1020	1100	300
		500	500	220	10	30	1500	1020	1100	300
2"	1	500	500	220	10	30	1500	1020	1100	300
		500	500	220	10	30	1500	1020	1100	300
		500	500	220	10	30	1500	1020	1100	300
3"	1	780	600	220	20	20	1560	1200	1100	400
		780	600	220	20	20	1560	1200	1100	400
		780	600	220	20	20	1560	1200	1100	400
		780	600	220	29	20	1560	1200	1100	580
		780	600	220	29	20	1560	1200	1100	580
		780	600	220	29	20	1560	1200	1100	580
4"	1	1020	730	220	27	10	1500	1020	1100	270
		1020	730	220	37	10	1500	1020	1100	370
		1020	730	220	37	10	1500	1020	1100	370
		1020	730	220	37	10	1,500	1020	1100	370
6"	1	1090	790	375	70	1	1090	790	375	70
		1090	790	375	84	1	1090	790	375	84
		1090	790	375	84	1	1090	790	375	84
		1090	790	375	84	1	1090	790	375	84
8"	1	1390	990	375	92	1	1390	990	375	92
		1390	990	375	108	1	1390	990	375	108
		1390	990	375	108	1	1390	990	375	108
		1390	990	375	108	1	1390	990	375	108
		1390	990	375	108	1	1390	990	375	108

ScreenGuard™

Netafim™ manual on line metal screen filters, angle model, offer high corrosion and UV protection with large filtration area which result to better filtration efficiency, excellent irrigation uniformity and less maintenance.

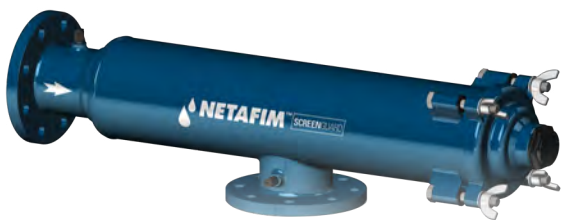
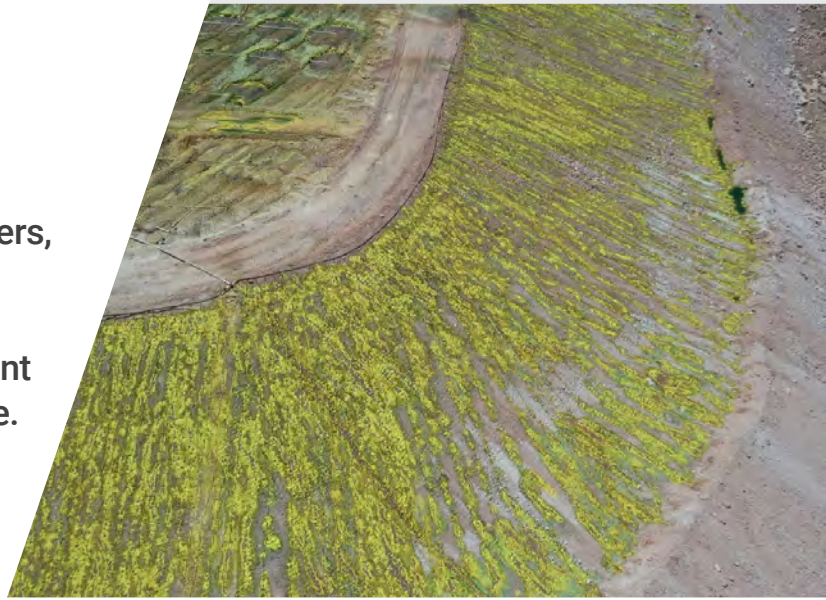

Wide filtration area



High durability



Extremely versatile

/ Benefits & Features

- **Wide filtration area** Results in lower labor cost due to longer cleaning intervals even in harsh water conditions.
- **High corrosion and UV resistance** The filter housing is coated with dual layers for better UV and corrosion protection.
- **Versatile** Different micron rating screens suit a variety of applications.

/ Specifications

- Filter screen cylinder molded with stainless-steel 316L screen.
- With multiple filtration area options covering a wide range of flow rates, ensures a perfect fit for different water quality and protection requirements.
- Maximum operating pressure: 10 bar (145 psi).

→ **Technical dimensions**

Connection diameter	A (mm)	B (mm)	C (mm)	D (mm)*	E (mm)*
1½"	150	210	420	225	645
2"	150	210	406	220	626
3"	150	340	673	477	1150
4"	150	460	916	729	1645
6"	250	450	938	702	1640
8"	250	630	1302	1023	2325

* Minimum distance to draw screen

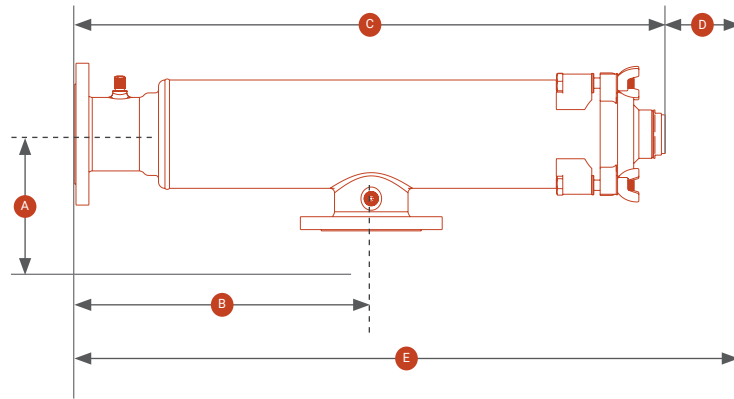

→ **Technical information**

Model	Filtration area (cm ²)	Available connection types	Maximum recommended flow rate (m ³ /h)	Drain valve diameters	Max. working pressure (bar)
1½"	850	BSP / NPT	15	2"	10
2"	850	BSP / NPT / VIC	25	2"	10
3"	1700	BSP / NPT / VIC / ANSI / ISO / BSTD	50	2"	10
4"	2550	VIC / ANSI / ISO / BSTD	80	2"	10
6"	4000	VIC / ANSI / ISO / BSTD	160	2"	10
8"	6350	VIC / ANSI / ISO10 / VIC16 / BSTD	250	2"	10

→ **Head loss**

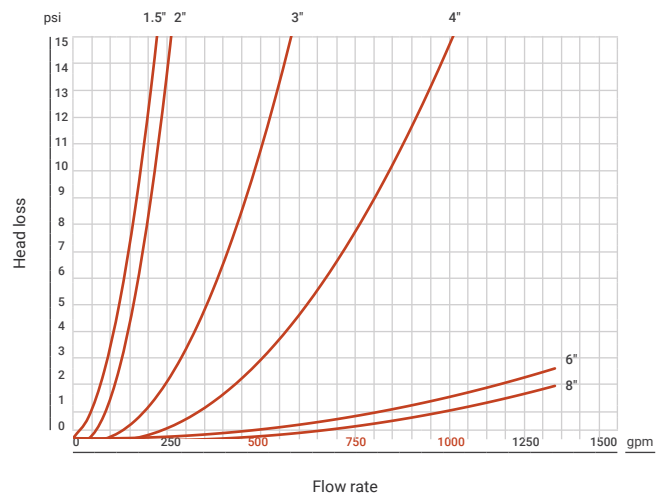
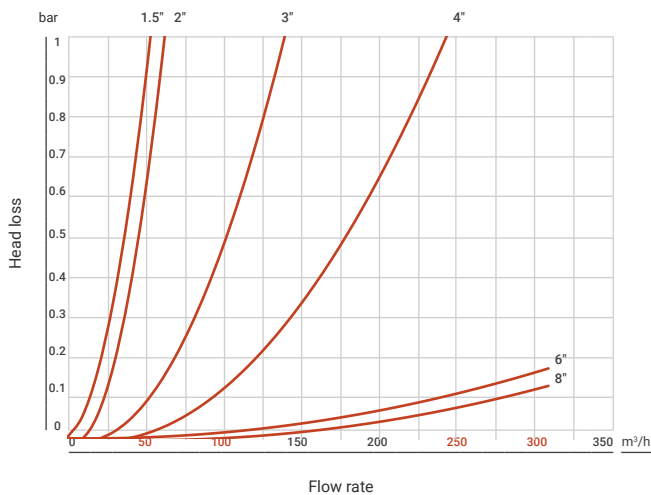

→ **Catalog numbers**

The type of filter and his catalog number will be determined according to the specific conditions in each application. For a correct configuration of a required filter please contact us at Mining@netafim.orbia.com or contact your Netafim™ local representative.

→ **Logistic data**

Model	Box					Pallet (including the pallet)				
	Qty. in box	Length (mm)	Width (mm)	Height (mm)	Gross weight p/box (kg)	Qty. of boxes in pallet	Length (mm)	Width (mm)	Height (mm)	Gross weight p/pallet (kg)
1 1/2"	1	630	270	220	10	40	1260	1080	1100	400
		630	270	220	10	40	1260	1080	1100	400
2"		600	270	220	10	40	1260	1080	1100	400
		600	270	220	10	40	1260	1080	1100	400
3"		870	270	220	18	25	1140	1080	1100	450
		870	270	220	18	25	1140	1080	1100	450
		870	270	220	18	25	1140	1080	1100	450
		870	270	220	27	25	1140	1080	1100	675
		870	270	220	27	25	1140	1080	1100	675
		870	270	220	27	25	1140	1080	1100	675
4"		1115	290	220	23	20	1140	1080	1100	460
		1115	290	220	33	20	1140	1080	1100	660
		1115	290	220	33	20	1140	1080	1100	660
		1115	290	220	33	20	1140	1080	1100	660
6"		1170	470	375	64	1	1170	470	375	64
		1170	470	375	77	1	1170	470	375	77
		1170	470	375	77	1	1170	470	375	77
		1170	470	375	77	1	1170	470	375	77
8"		1520	470	375	84	1	1520	470	375	84
		1520	470	375	102	1	1520	470	375	102
	1520	470	375	102	1	1520	470	375	102	
	1520	470	375	102	1	1520	470	375	102	
	1520	470	375	102	1	1520	470	375	102	

ScreenGuard™

Netafim™ semi-automatic on line screen filters, angle model, offer high corrosion and UV protection with large filtration area and cleaning mechanism which allows super-easy cleaning of the screen.



Wide filtration
area



High
durability



Extremely
versatile

/ Benefits & Features

- **Wide filtration area** Results in lower labor cost due to longer cleaning intervals even in harsh water conditions.
- **High corrosion and UV resistance** The filter housing is coated with dual layers for better UV and corrosion protection.
- **Versatile** Different micron rating screens suit a variety of applications.

/ Specifications

- Filter screen cylinder molded with stainless-steel 316L screen.
- With multiple filtration area options covering a wide range of flow rates, ensures a perfect fit for different water quality and protection requirements.
- Maximum operating pressure: 10 bar (145 psi).

→ **Technical dimensions**

Connection diameter	A (mm)	B (mm)	C (mm)	D (mm)*	E (mm)*
1½"	210	150	667	917	250
2"	210	150	653	903	250
3"	340	150	920	1,410	490
4"	460	150	1161	1911	750
6"	450	250	1226	1916	690
8"	630	250	1690	2750	1060

* Minimum distance to draw screen

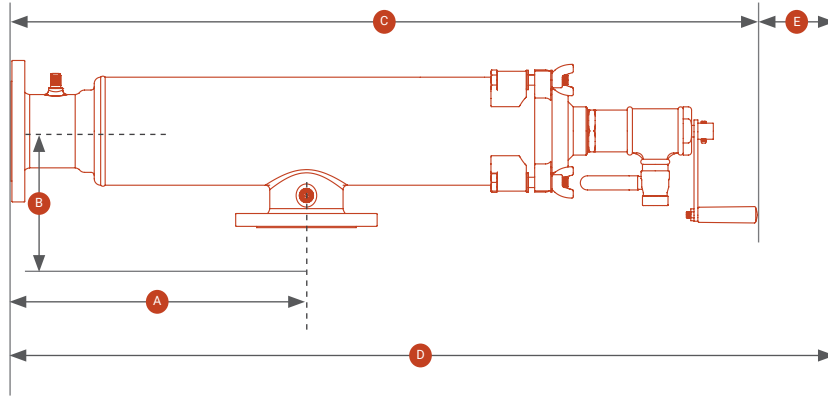

→ **Technical information**

Model	Filtration area (cm²)	Available connection types	Maximum recommended flow rate (m³/h)	Max. working pressure (bar)
1½"	850	BSP / NPT	15	10
2"	850	BSP / NPT / VIC	25	10
3"	1700	BSP / NPT / VIC / ANSI / ISO / BSTD	50	10
4"	2550	VIC / ANSI / ISO / BSTD	80	10
6"	4000	VIC / ANSI / ISO / BSTD	160	10
8"	6350	VIC / ANSI / ISO10 / VIC16 / BSTD	250	10

→ **Head loss**

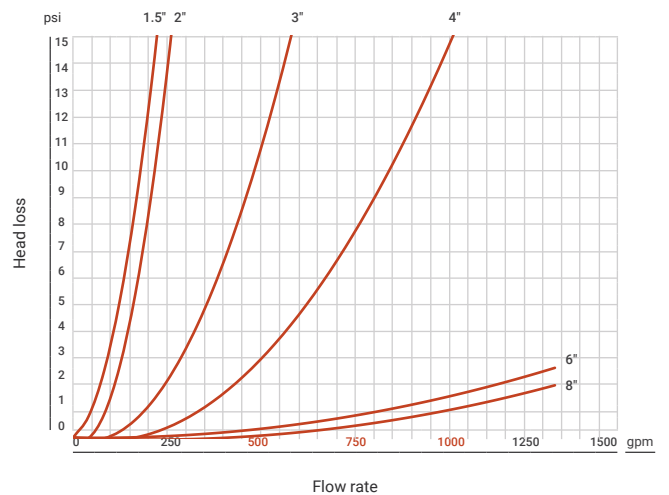
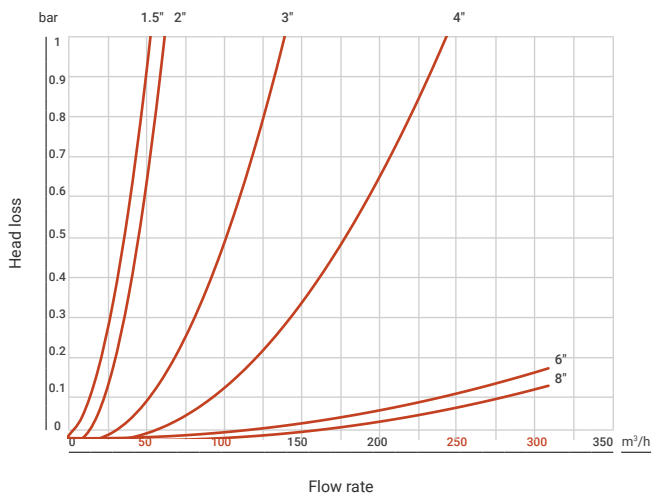

→ **Catalog numbers**

The type of filter and his catalog number will be determined according to the specific conditions in each application. For a correct configuration of a required filter please contact us at Mining@netafim.orbia.com or contact your Netafim™ local representative.

→ **Logistic data**

Model	Qty. in box	Box				Pallet (including the pallet)				
		Length (mm)	Width (mm)	Height (mm)	Gross weight p/box (kg)	Qty. of boxes in pallet	Length (mm)	Width (mm)	Height (mm)	Gross weight p/pallet (kg)
1½"	1	630	270	220	10	40	1260	1080	1100	400
		630	270	220	10	40	1260	1080	1100	400
2"	1	600	270	220	10	40	1260	1080	1100	400
		600	270	220	10	40	1260	1080	1100	400
3"	1	870	270	220	18	25	1140	1080	1100	450
		870	270	220	18	25	1140	1080	1100	450
		870	270	220	18	25	1140	1080	1100	450
		870	270	220	27	25	1140	1080	1100	675
		870	270	220	27	25	1140	1080	1100	675
4"	1	1115	290	220	23	20	1140	1080	1100	460
		1115	290	220	33	20	1140	1080	1100	660
		1115	290	220	33	20	1140	1080	1100	660
		1115	290	220	33	20	1140	1080	1100	660
6"	1	1170	470	375	64	1	1170	470	375	64
		1170	470	375	77	1	1170	470	375	77
		1170	470	375	77	1	1170	470	375	77
		1170	470	375	77	1	1170	470	375	77
8"	1	1520	470	375	84	1	1520	470	375	84
		1520	470	375	102	1	1520	470	375	102
		1520	470	375	102	1	1520	470	375	102
		1520	470	375	102	1	1520	470	375	102

Hydrocyclone

Netafim™ sand separator. Utilizing a conical shaped separator that accelerates the velocity of water maximizing separation of sand and other solid matter to protect the irrigation components from damage and abrasion.

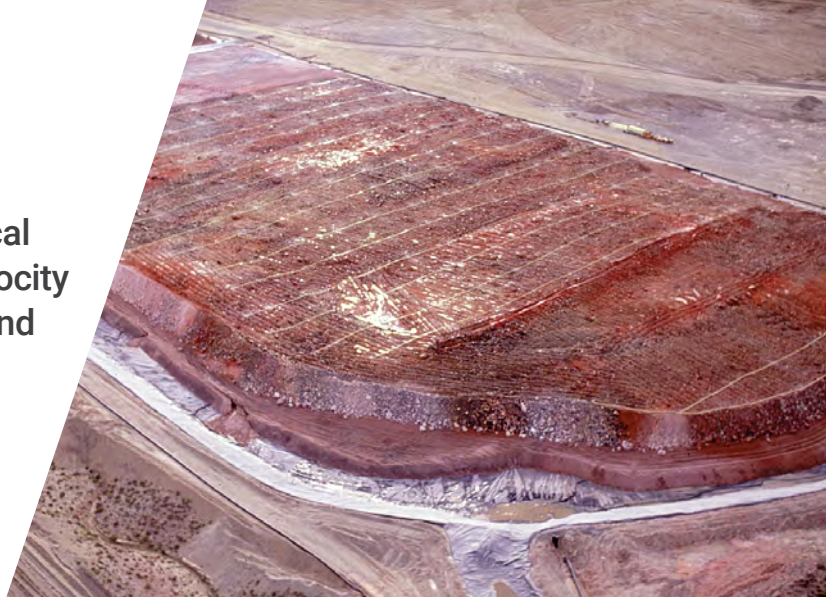

Very high efficiency



High durability



User friendly

/ Benefits & Features

- | | |
|------------------------------------|---|
| → Maximum protection | Conical shape accelerates the velocity of the water increasing centrifugal forces and maximizing separation. |
| → High corrosion and UV resistance | Coated with dual layer electrostatic baked powder coating (Phenolic & Polyester) with thickness of 150 micron each. |
| → User friendly | No moving parts or screens and no head loss build-up or clogging during separation. |
| → Specially designed | Conical rubber protection to protect the cone from erosion. |

/ Specifications

- Made from high quality carbon steel ST37.2, treated with sand blasting of up to Sa 2.5 grade.
- Large holding capacity of sedimentation tank reduces flushing frequency.
- Wide range of end connection and sedimentation tanks capacity.
- Maximum operating pressure: 10 bar (145 psi).

→ Technical dimensions

Hydrocyclone model	Sedimentation chamber model	Dimensions									Drain socket diameter
		D (inch)	D1 (inch)	H (mm)	H1 (mm)	H2 (mm)	L (mm)	L1 (mm)	W (mm)	W1 (mm)	
¾"	1.5L - ½" Thread	¾	3	475	380	95	332	130	180	31	½"
1"	1.5L - ½" Thread	1	4	600	460	140	332	160	180	40	½"
1"	2.5L - ½" Thread	1	4	600	460	140	442	160	180	40	½"
1½"	2.5L - ½" Thread	1½	6	740	594	146	450	260	180	60	½"
2"	12I - 3" Vic	2	8	900	755	145	562	305	320	80	2"
3"	12I - 3" Vic	3	8	930	765	165	562	305	320	65	2"
3"	30I - 3" Vic	3	8	1032	867	165	797	305	400	65	2"
3" Super	12I - 3" Vic	3	8	930	765	165	562	305	320	65	2"
3" Super	30I - 3" Vic	3	8	1032	867	165	797	305	400	65	2"
4"	60I - 4" Flange	4	12	1550	1285	265	800	465	550	104	2"
4" Super	60I - 4" Flange	4	16	1765	1495	270	835	500	550	138	2"
4" Super	120I - 4" Flange	4	16	1883	1613	270	967	500	650	138	2"
6"	120I - 8" Flange	6	20	1996	1671	325	1037	605	650	165	2"
6" Super	120I - 8" Flange	6	24	2300	1940	360	1087	655	650	215	2"
6" Super	240I - 8" Flange	6	24	2414	2054	360	1223	655	750	215	2"
8"	240I - 8" Flange	8	30	2897	2492	405	1273	705	750	265	2"

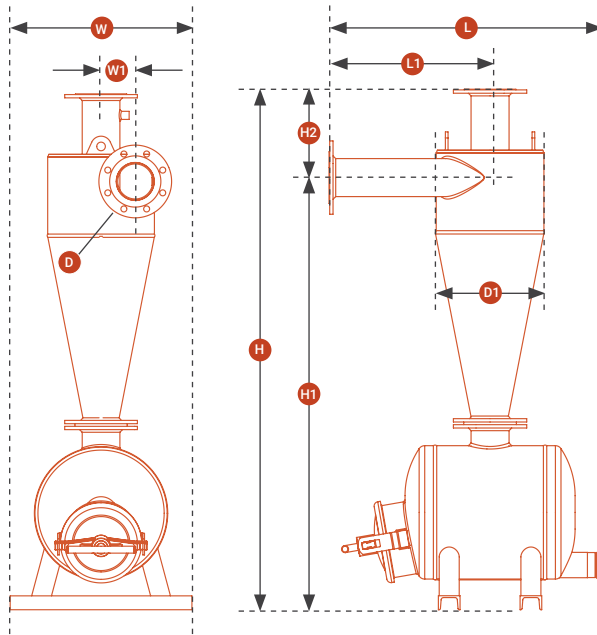

→ Technical information

Model	In / out diameter (inch)	Sedimentation tank capacity		Recommended flow rate range				Connection types
				m³/h		gpm		
		Liter	Gallons	Min	Max	Min	Max	
¾"	¾"	1.5	0.4	2.4	4	10.6	17.2	BSP / NPT
1"	1"	2.5	0.66	3.5	6	15.4	26.4	BSP / NPT
1½"	1½"	2.5	0.66	6.5	10	28.6	44	BSP / NPT
2"	2"	12	3	12.5	20	55	88	BSP / NPT / VIC
3"	3"	12 / 30	3 / 8	19.5	30	86	132	BSP / NPT / VIC / Flange
3"S	3"	12 / 30	3 / 8	27	42	119	185	BSP / NPT / VIC / Flange
4"	4"	60	16	35	61	154	269	VIC / Flange
4"S	4"	60 / 120	16 / 32	59	95	260	418	VIC / Flange
6"	6"	120	32	88	147	387	647	VIC / Flange
6"S	6"	120 / 240	32 / 63	126	205	555	903	VIC / Flange
8"	8"	240	63	205	400	903	1761	VIC / Flange

Flow rate are based on recommended head loss of 2- 5m' (3 - 7psi)

→ **Catalog numbers**

The type of filter and his catalog number will be determined according to the specific conditions in each application. For a correct configuration of a required filter please contact us at Mining@netafim.orbia.com or contact your Netafim™ local representative.

→ **Logistic data**

Hydrocyclone model	Sedimentation chamber model	Quantity in box	Box length (mm)	Box height (mm)	Box width (mm)	Gross weight p/box (kgs)
¾"	1.5	1	610	220	410	8.5 (Thread)
1"	2.5		610	220	410	11 (Thread)
1½"	2.5		610	220	410	15 (Thread)
2"	12		730	530	650	34 (Thread, VIC)
3"	12		730	530	650	36 (Thread, VIC) 43 (Flange)
3"	30		1100	650	700	72 (Thread, VIC) 80 (Flanged)
3" Super	12		730	530	650	36 (Thread, VIC) 43 (Flange)
3" Super	30		1100	650	700	72 (Thread, VIC) 80 (Flanged)
4"	60		1100	730	950	86 (VIC) 95 (Flanged)
4" Super	60		1300	730	950	95 (VIC) 104 (Flanged)
4" Super	120		1450	880	1050	113 (VIC) 122 (Flanged)
6"	120		1500	530	1150	150 (VIC) 164 (Flanged)
6" Super	120		1950	830	1150	172 (VIC) 185 (Flanged)
6" Super	240		2300	980	1200	200 (VIC) 214 (Flanged)
8"	240	2250	1030	1450	276 (VIC) 294 (Flanged)	

→ Head loss

3/4" - 1 1/2"

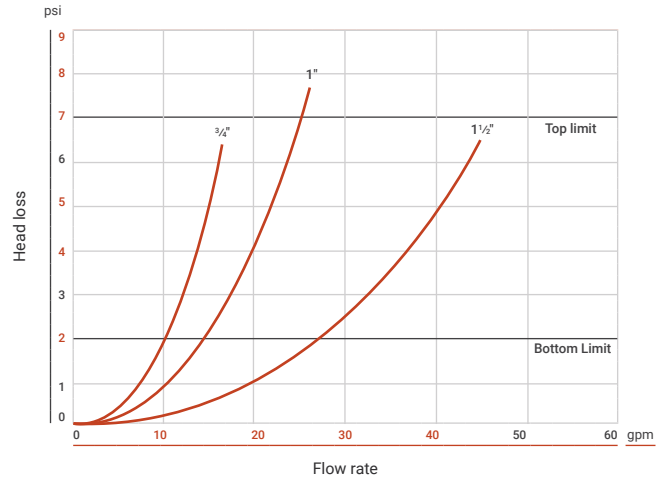
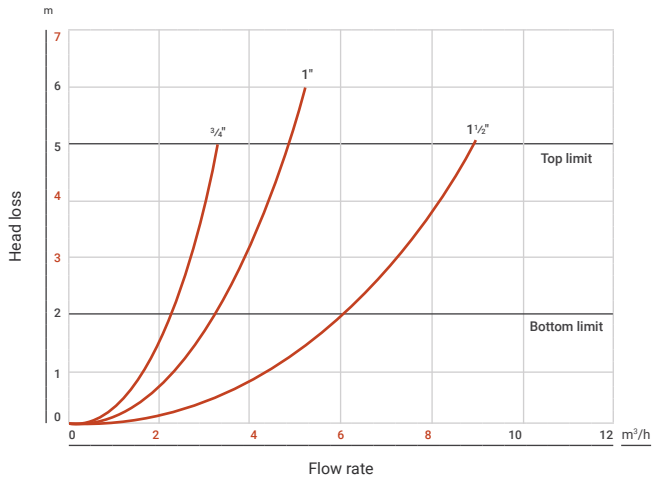

2" - 4"

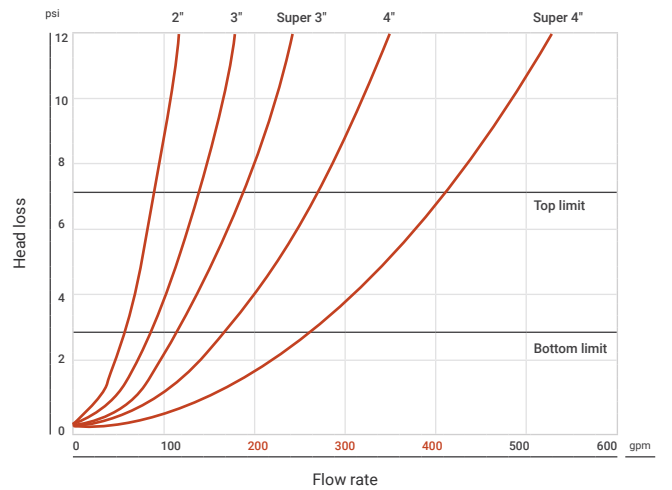
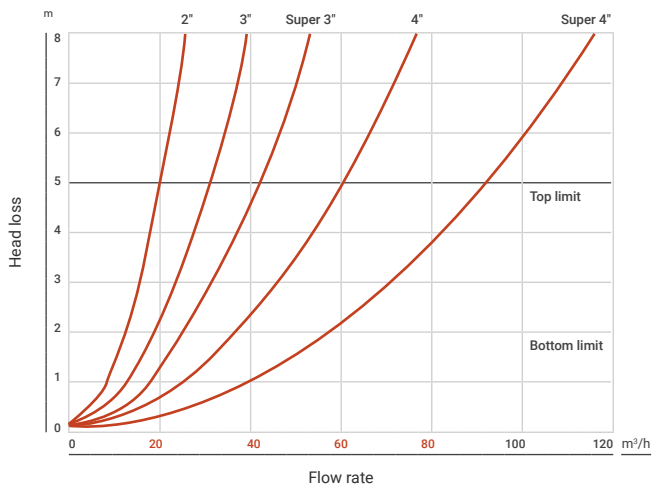

6" - 8"

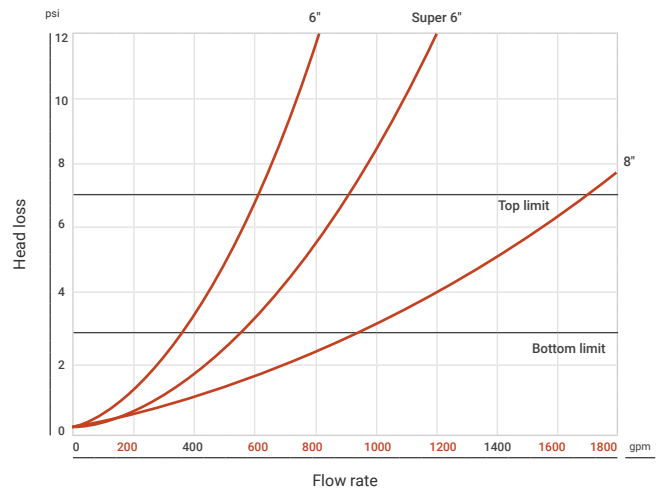
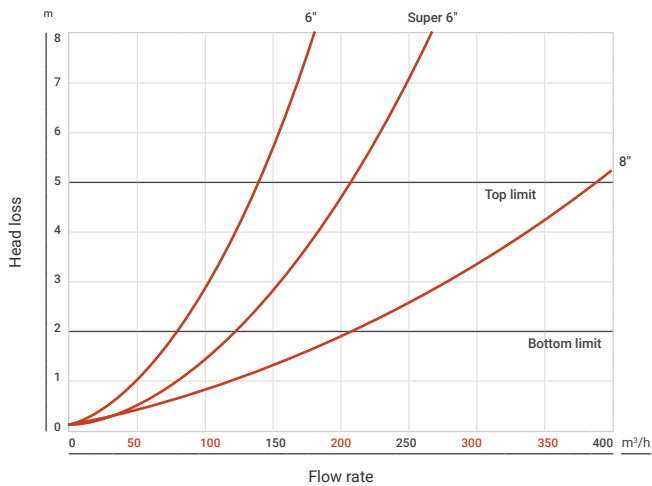

/ Netafim™ Products Warranty

All drippers, driplines and Netafim™ products

Netafim's products are warranted to be free from defects in material and workmanship under normal use and service, for the periods set out in the applicable table below in respect of each of the products (for each product, its respective "Warranty Period"), from the date of receipt of the product(s) by the person, firm, or company who purchases the products from Netafim™ (the "Customer"), as stated in a valid products acceptance certificate (the "Commencement Date"), subject to the Customer presenting such certificate.

Table 1 (driplines)

Table 2 (complementary products, sprinklers)

/ Limited Warranty

Netafim's products are warranted to be free from defects in material and workmanship under normal use and service, for the applicable Warranty Period, provided however, that with respect to items procured by Netafim™ from a third party, such warranty period shall be the shorter of (i) the Warranty Period; or (ii) the warranty period granted to Netafim™ by the third party from which it acquired such item.

This limited warranty shall be considered as null and void and shall not apply in any of the following events:

1. Where equipment is not used or has not been installed in accordance with Netafim's specifications and/or installation instructions for the recommended purpose. This warranty does not extend to repair or replacement (or attempts to repair or replace) of a Netafim™ product or part that results from misuse, negligence, alteration, tampering, use in conjunction with parts, products or services which have not been approved by Netafim™, improper or inadequate storage, installation or maintenance of the product, or any use not in accordance with the applicable user manual provided by Netafim™.
2. Where chemical concentrates are used or applied internally or externally to the product not according to Netafim's instructions, and cause harm to the product or its components.
3. If operating pressures are not within the limits specified by Netafim™ in the Technical Product Sheet of each individual component.
4. If water composition is not within the limits specified by Netafim™ in the Technical Product Sheet of each individual component.
5. Where damage, plugging or clogging is caused by insects, rodents or other animals.
6. Normal wear and tear.
7. Any part normally consumed in operation, or which has a normal life, inherently shorter than the specified Warranty Period, shall not be considered defective merely due to its consumption or failure prior to the end of the Warranty Period.
8. Loss or damage in transit in the event that the Customer was responsible for transporting the products.
9. Any acts or omissions which expose the products to any harmful environmental factors, including without limitation, use of toxic, corrosive, or caustic liquids, solids, and/or gases, exposure to severe weather conditions, or exposure to unsuitable water.
10. If failures are caused by any act or event beyond the reasonable control of Netafim™, including, without limitation: natural calamities and/or force majeure, which may include, but are not limited to, war, invasion, act of foreign enemy, terrorism, hostilities (whether war be declared or not), civil war or strike, rebellion, lockouts or other industrial disputes or actions, acts of God, acts of government or other prevailing authorities or defaults of third parties, storms, temperatures, flooding, gales, snow, landslides, fire, hailstorm, lightning, earthquakes, electrical or power failures or outages or power surges or electrical spikes, or damage due to freezing or mechanical damage, failure of energy or water supply.

Upon identifying a defect in a Netafim™ product or part thereof during the applicable Warranty Period, the Customer shall provide written notice of the claimed defect to Netafim™ within fifteen (15) calendar days of the discovery thereof or when the Customer should have become aware of such defect and return the defective Netafim™ product or part to Netafim™. Netafim™ will, at its sole discretion, either repair, replace, or refund a part or the full cost of the defective product's or part's purchase price.

Netafim's warranty does not cover spare parts required for routine maintenance. Netafim™ cannot and does not assume liability for defective parts, or damage or problems caused by products not manufactured or supplied by Netafim™, even though such products may be used in conjunction with Netafim™ products and the Customer assumes the risk of use of such third party products.

Netafim's obligation to repair, replace or refund the cost (in full or in part) of its products or parts as set forth above is the sole and exclusive warranty given by Netafim™. Netafim™ disclaims any and all other warranties, express or implied, including warranties of merchantability and fitness for a particular purpose and/ or warranty of non-infringement. Netafim™ will not be liable to any party in strict liability, tort, contract, or any other manner for damages caused or claimed to be caused as a result of any design or defect in Netafim's products. In addition, Netafim™ shall not be liable, and a Customer and/or any third party shall not be entitled to recover from Netafim™, any, general, special, incidental, consequential, indirect, punitive, or exemplary damages of whatsoever nature and type (including, without derogating from the generality of the foregoing, damages to crops or equipment caused by product malfunction, losses or damages caused by shutdowns or service interruptions, loss of use, non-operation of the products or any equipment, loss of information, loss of power or cost of replacement power, loss of profits or revenue, loss of contracts, loss of capital inventory or use charges, cost of purchased or replacement power, interest charges or cost of capital or claims of Customer's clients or any third party) even if Netafim™ is aware or should have been aware of the possibility of such damages. In no event shall Netafim's liability exceed the purchase price of the Netafim™ products.

Netafim™ reserves the right to alter, modify or redesign its products, pricing and this warranty at all times without creating any liability for the obsolescence of Customer inventory or such parts or products.

This warranty shall be subject to, and shall be exclusively governed by, the laws of the State of Israel, to the exclusion of its conflict of law rules. Any dispute arising out of or in respect of this warranty shall be subject to the jurisdiction of the courts in the State of Israel.

/ Netafim™ Products Warranty

Table 1 (driplines)

Product	Wall Thickness (mm/mil)	Period (Months)
Mining		
Leach Line™ U (16, 20 mm OD)	0.90/35.0	60
	1.00/39.0	60
	1.20/47.0	60
Leach Line™ D (16, 20 mm OD)	0.90/35.0	60
	1.00/39.0	60
	1.20/47.0	60
Leach Line™ X (16, 20 mm OD)	0.90/35.0	60
	1.00/39.0	60
	1.20/47.0	60
Leach Line™ A (16, 20 mm OD)	0.90/35.0	60
	1.00/39.0	60
	1.20/47.0	60

Table 2 (complementary products, sprinklers)

Product	Period (months)
Valves	
Hydraulic Valves	12
Air valves	12
Netafim™ Manual valves	12
Filters	
Sandstorm Tank and manifolds	60
ScreenGuard body, piston & cover	60
ScreenGuard - bearings	24
Disc filters	24
Accessories	
Connectors	48
Venturi injectors	12
System Accessories	48
Pressure regulators, models 2000 and In line	120
Flexible Pipes	
FlexNet™ and FlexNet™ HP	36
Sprinklers	
GyroNet™, MegaNet™	Within first years of purchase, refund of 100% of product cost
	Within 2 years of purchase, refund of 75% of product cost
	Within 3 years of purchase, refund of 50% of product cost

Table 2 (complementary products, sprinklers)

Product	Period (months)
Blank PE tubing (ISO8779)	
On surface installation	72
Sub surface installation	120
Water meters	12

06-0824-MINING-CAT-00-53-EN



www.netafim.com