

Sandstorm™

SINGLE CHAMBER METAL MEDIA FILTER

Sandstorm media filters offers high quality media filters made from carbon steel ST-37.2 in a modular configuration with high UV and corrosion protection and with the industrial leading warranty, produces healthier crops, higher yields and more profitable farming.



Maximum Protection



High Corrosion and UV Resistance



Ease of Maintenance

Benefits & Features

- ✓ High quality carbon steel media filters
- ✓ Industry leading UV/Corrosion protection due to special two layers coating
- ✓ Maximum protection and reliability in harsh conditions
- ✓ Flexible and modular design allows for future expansion as needed
- ✓ Easy installation and maintenance due to large and multiple access ports
- ✓ Mounted rings for mobile system installations
- ✓ Wide range of double and single chamber diameters
- ✓ Industry leading warranty

→ APPLICATIONS

- Primary filtration for irrigation systems using Surface water from Rivers, Streams and Canals that contain organic matter and in many cases silt and/or clay
- Irrigating systems irrigating with dripperlines in poor surface water quality in multiple season applications
- For water contain Iron (with special media)

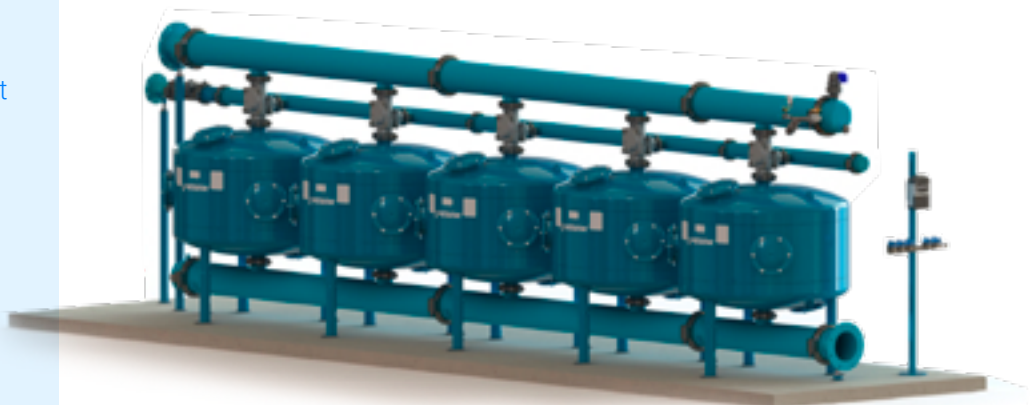

→ HYDRAULIC PERFORMANCE

TANK DIAMETER	FILTRATION AREA		MAXIMUM RECOMMENDED FLOW RATE		BACK FLUSH FLOW RATE				MINIMUM BACK FLUSH PRESSURE BAR/PSI	MAXIMUM OPERATING PRESSURE BAR/PSI
					BASALT NUMBER 1		SILICA 16			
	M ²	FT ²	M ³ /H	GPM	M ³ /H	GPM	M ³ /H	GPM		
30"	0.45	4.84	30	130	36	160	20	88	2/30	8/115
36"	0.65	7	45	200	50	220	28	125		
48"	1.13	12.16	80	350	80	350	43	190		

* Maximum recommended flow rate is based on good water quality and calculated with velocity of 70 m/h

→ TECHNICAL DIMENSIONS

TANK DIAMETER	D (IN.)	D1 (IN.)	H1		H2		H		L		EMPTY TANK WEIGHT		SAND QUANTITY*	
			MM	IN.	MM	IN.	MM	IN.	MM	IN.	KG	LB	KG	LB
			30"	3	30					1,376	54.15	820	32.30	120
36"	3	36	406	16	1,371	54	1,378	54.25	1,034	40.70	155	341	475	1,047
48"	4	48					1,380	54.35	1,268	49.90	235	517	900	1,984
48" (HIGH)	4	48	443	17.44	1,408	55.43	1,417	55.80	1,268	49.90	235.5	519	900	1,984

* Media weight based on Silica 16

→ CONFIGURATION

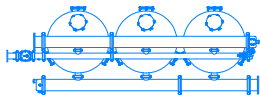

STRAIGHT-LINE

Number of tanks: 2-5

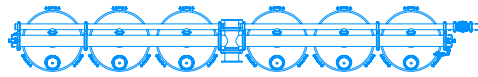

STRAIGHT-LINE CENTER FEED

Number of tanks: 5-10

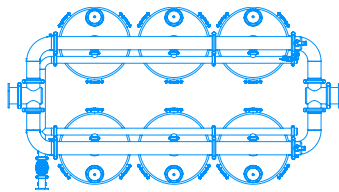

PARALLEL

Number of tanks: 5 and up

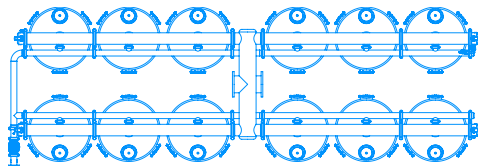

H-SYSTEM

Number of tanks: 5 and up

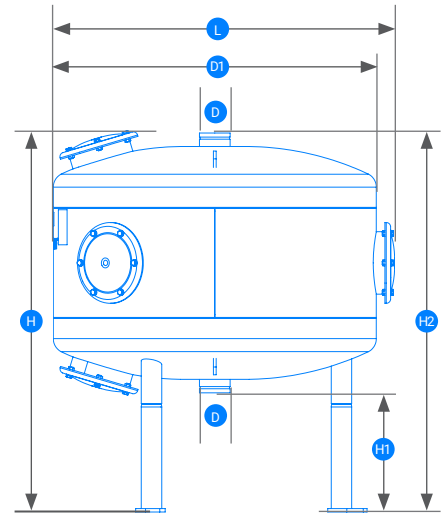

→ HEAD LOSS

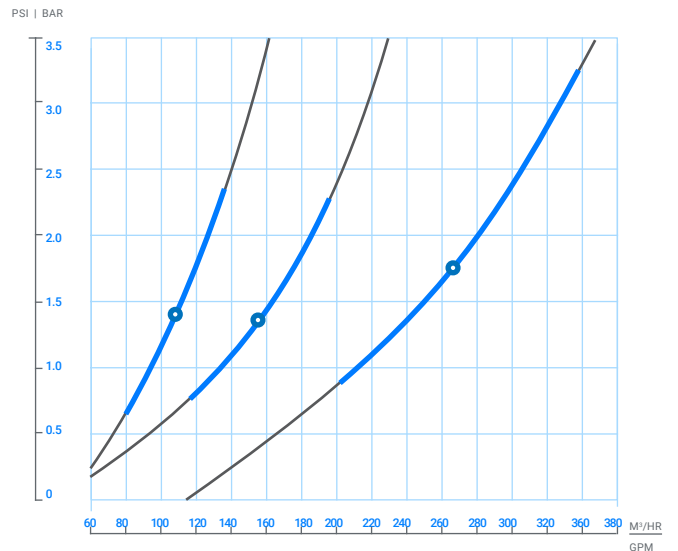
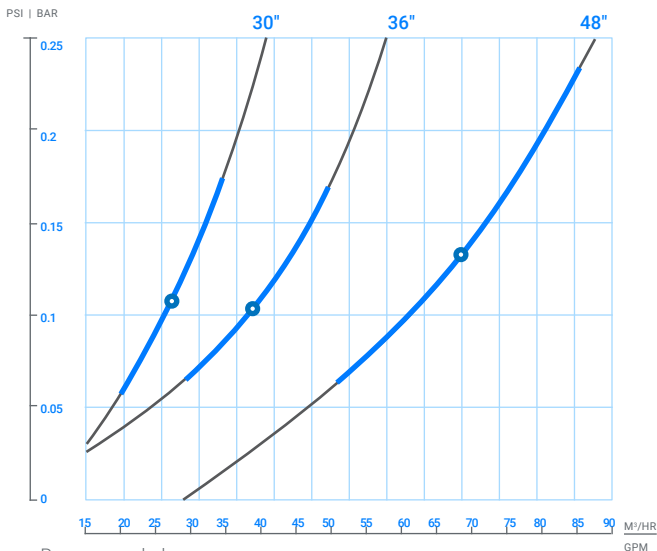

— Recommended range

● Average